

1 2 3 4 5 6 7 8

A
B
C
D
E
F

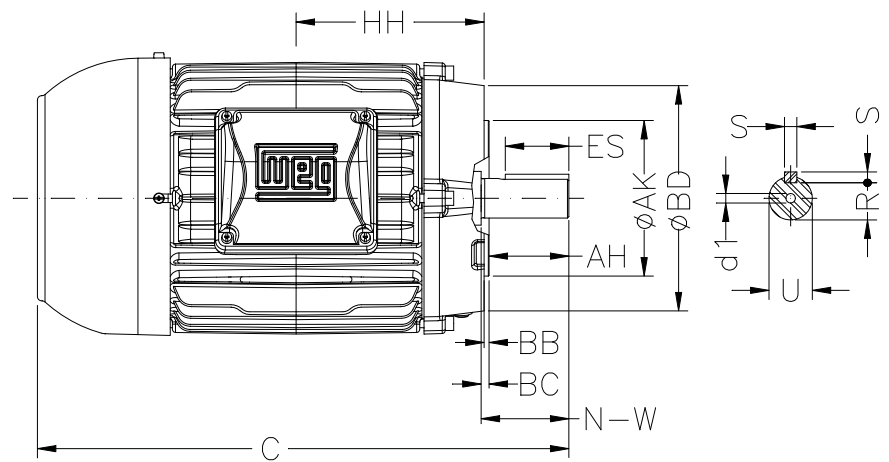
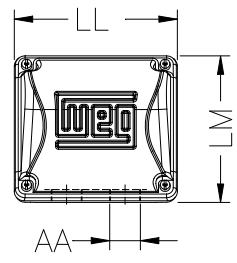
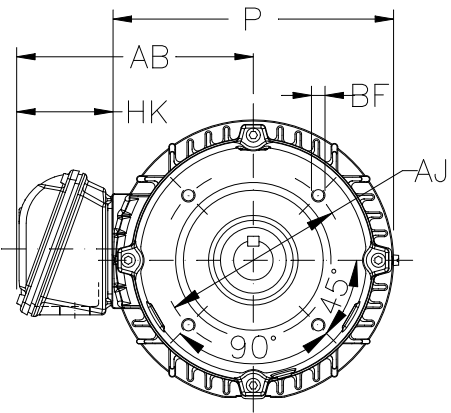

Notes: Downloaded from <http://dealerselectric.com>
Generated for Model #00156EP3ER143TC-W22

Performed by:

Checked:

Customer:

W22 High Efficiency

P	AB	U	N-W	ES
7.244	6.260	0.875	2.250	1.575
S	R	depth	HH	HK
0.187	0.771	0.187	4.250	2.638
C	LL	LM	AA	d1
12.346	4.528	4.094	NPT 3/4"	A 3,15
Flange	AJ	AK	BD	BF
FC-149	5.875	4.500	6.500	UNC 3/8"x16
BB	BC	AH		
0.157	0.125	2.125		

Three-phase induction motor
Frame 143T - IP55

12-SEP-2016

