

1 2 3 4 5 6 7 8

A

B

C

D

E

F

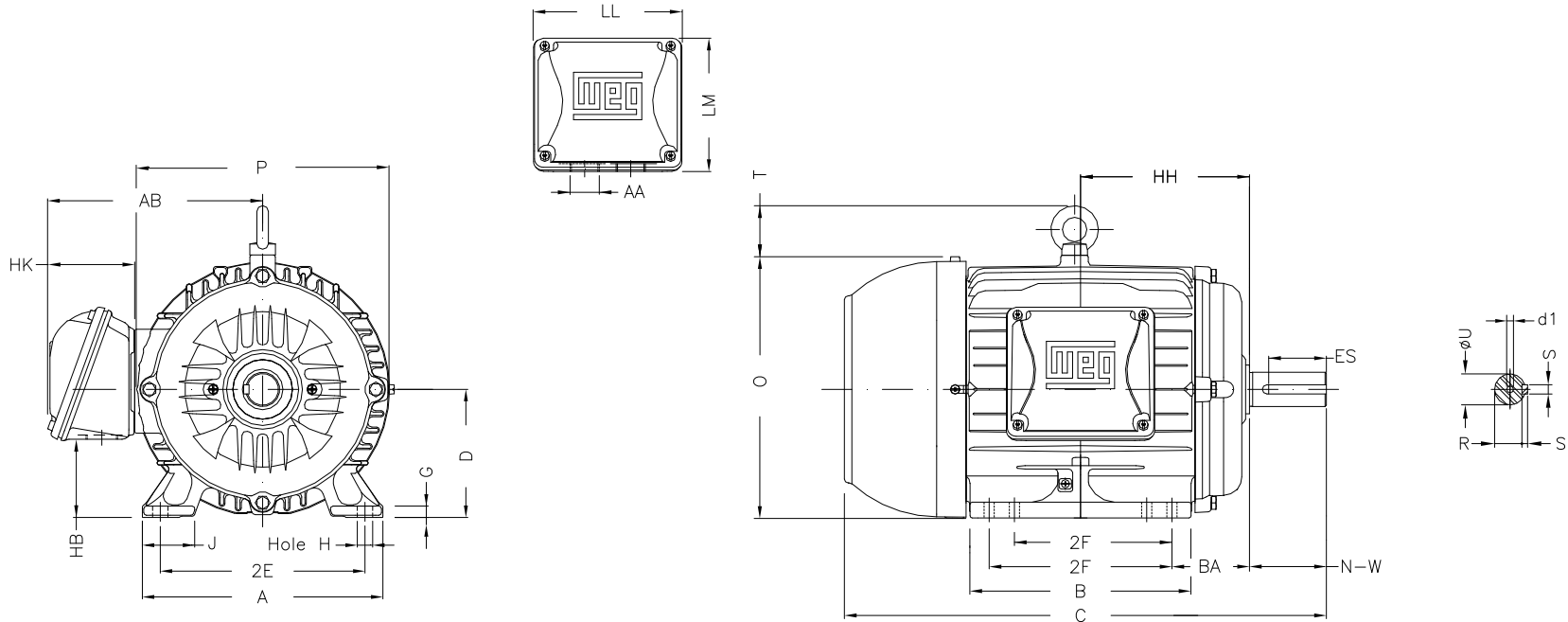

Notes: Downloaded from <http://dealerselectric.com>
Generated for Model #00152ST3HIE182T-W22

Performed by:

Checked:

Customer:

Three-Phase: W22 IEEE-841™ Petrochem Motors - NEMA Premium® Efficiency

Three-phase induction motor
Frame 182/4T - IP55

12-SEP-2016



2E 7.500	J 1.614	A 8.661	P 8.740	AB 7.565
2F 4.500/5.500	B 6.969	BA 2.750	U 1.125	N-W 2.750
ES 1.969	S 0.250	R 0.984	depth 0.250	D 4.500
G 0.374	HB 2.236	O 9.400	T 1.715	HF 4.500
HH 5.500	HK 3.150	H 0.406	C 15.860	LL 5.512
LM 5.236	AA NPT 1"	d1 A 4	d2 A 4	