

1 2 3 4 5 6 7 8

A
B
C
D
E
F

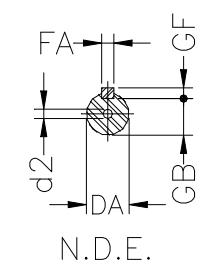
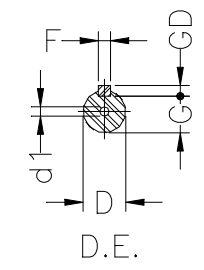
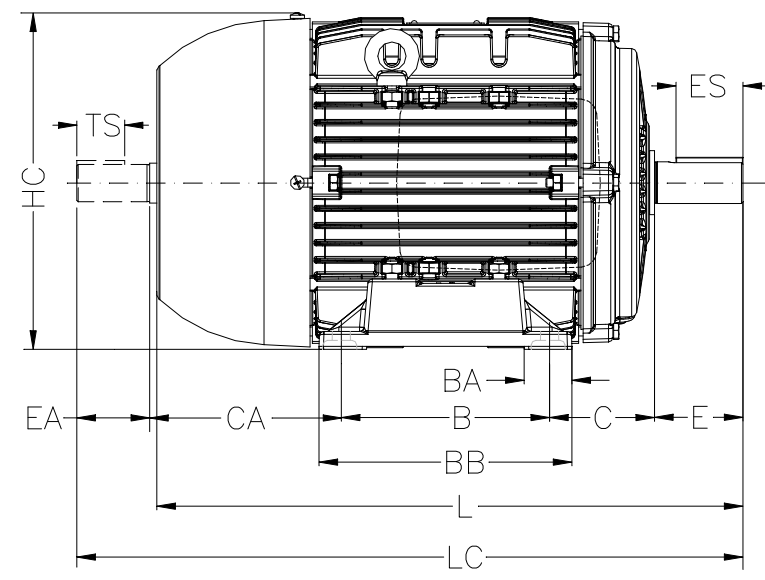
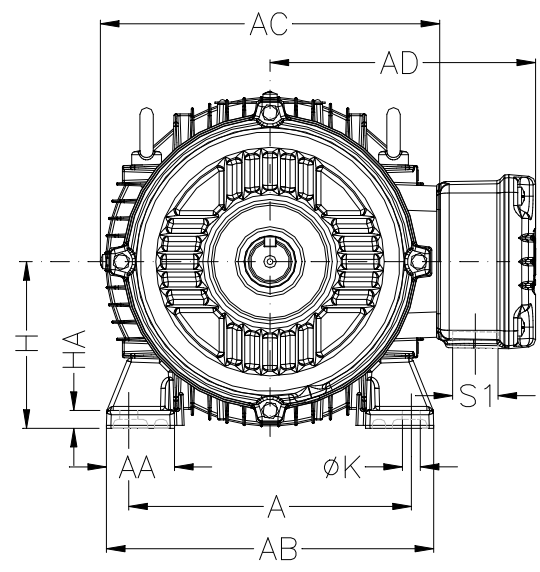

Notes: Downloaded from <http://dealerselectric.com>
Generated for Model #00152ET3WAL100L

A	AA	AB	AC	AD
160	40	196	200	165
B	BA	BB	C	CA
140	30	170	63	118
D	E	ES	F	G
28j6	60	45	8	24
GD	DA	EA	TS	FA
7	22j6	50	36	6
GB	GF	H	HA	HC
18.5	6	100	12	198
HD	K	L	LC	d1
260	12	376	431	DM10
d2				
DM8				

Performed by:
Checked:
Customer:
Three-Phase: W21 IE3 IEC Tru-Metric - TEFC (IP55) Multi-Mounting Aluminum
Three-phase induction motor
Frame 100L - IP55
12-SEP-2016
