

1 2 3 4 5 6 7 8

A

B

C

D

E

F

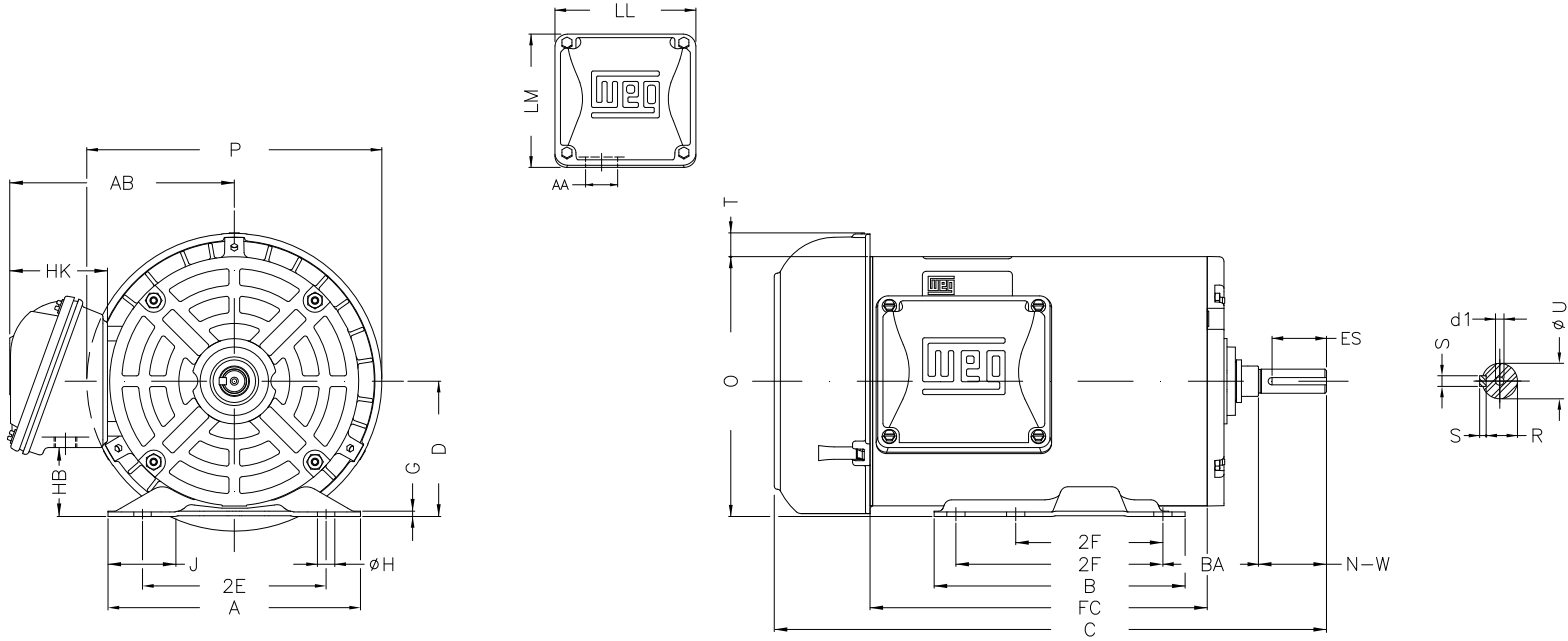

Notes: Downloaded from <http://dealerselectric.com>  
Generated for Model #00136ET3H143T-S

Performed by:

Checked:

Customer:

Three Phase: W01 (Rolled Steel) - TEFC - NEMA Premium Efficiency

Three-phase induction motor  
Frame 143/5T - IP55

12-SEP-2016



P	AB	J	2E	A
7.638	5.882	1.732	5.500	6.535
H	G	HB	HK	T
0.343	0.120	1.783	2.638	0.603
O	FC	2F	B	C
6.724	7.480	4.000/5.000	6.496	13.189
BA	N-W	ES	d1	S
2.250	2.250	1.417	A 3,15	0.187
U	AA	depth	R	LL
0.875	1.118"	0.187	0.771	4.543
LM	BB	D	CH	
4.106	0.603	3.500	1.377	