

1 2 3 4 5 6 7 8

A

B

C

D

E

F

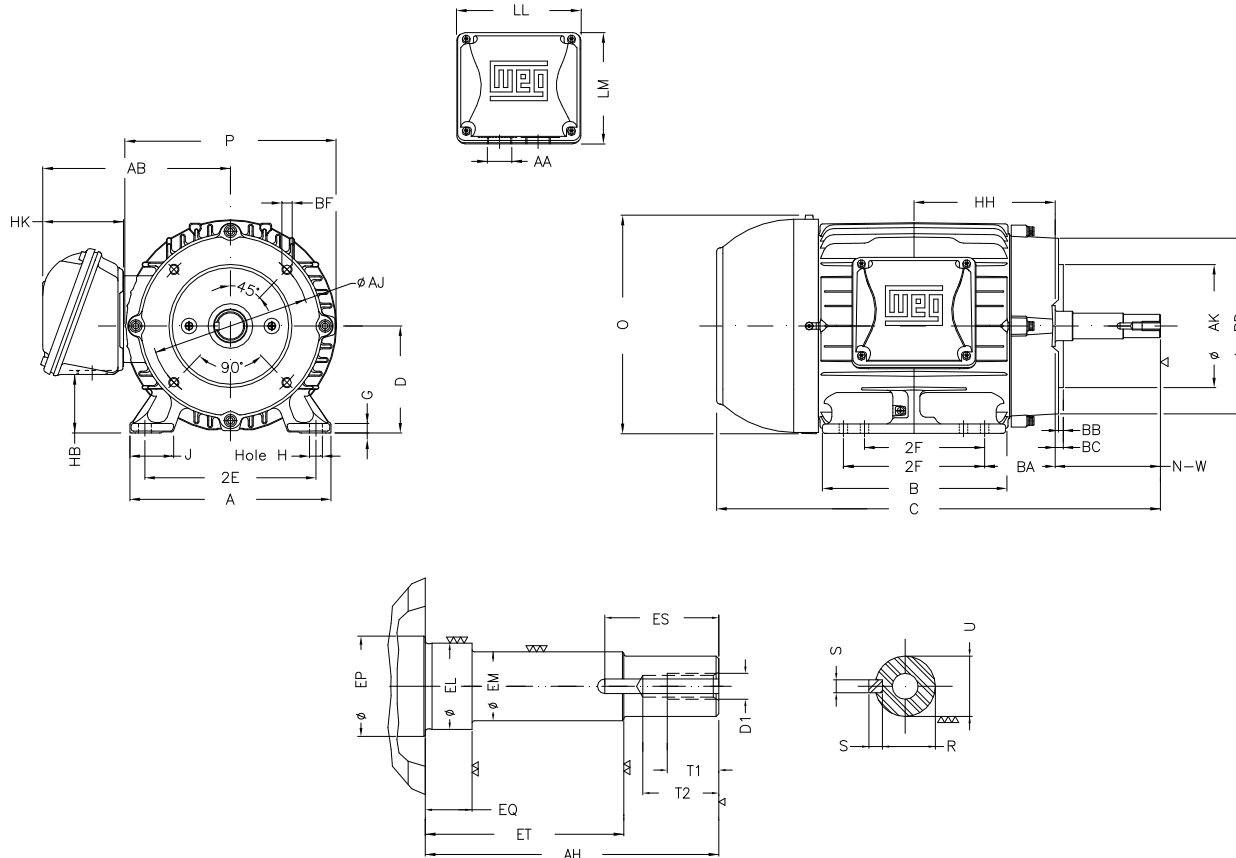

Notes: Downloaded from <http://dealerselectric.com>
Generated for Model #00118ET3E143JM-W22

Performed by:

Checked:

Customer:

Close Coupled Pump: Three-Phase - W22 "JM" Type - TEFC - NEMA Premium

Three-phase induction motor
Frame 143/5JM - IP55

12-SEP-2016



2E	J	A	P	AB
5.500	1.437	6.457	7.047	6.260
2F	B	BA	D	G
4.000/5.000	6.142	2.560	3.500	0.354
O	H	AA	EQ	ET
7.122	0.344	NPT 3/4"	0.630	2.880
U	EM	EL	EP	ES
0.874	1.000	1.156	1.179	1.654
t1	t2	C	d1	HH
0.748	1.102	15.675	EUNC 3/8"-16	4.750
HK	HB	LL	LM	S
2.638	1.787	4.528	4.094	0.187
R	Flange	AJ	AK	BD
0.767	FC-149	5.874	4.500	6.496
BF	BB	AH		
UNC 3/8"x16	0.157	4.258		