

1 2 3 4 5 6 7 8

A
B
C
D
E
F

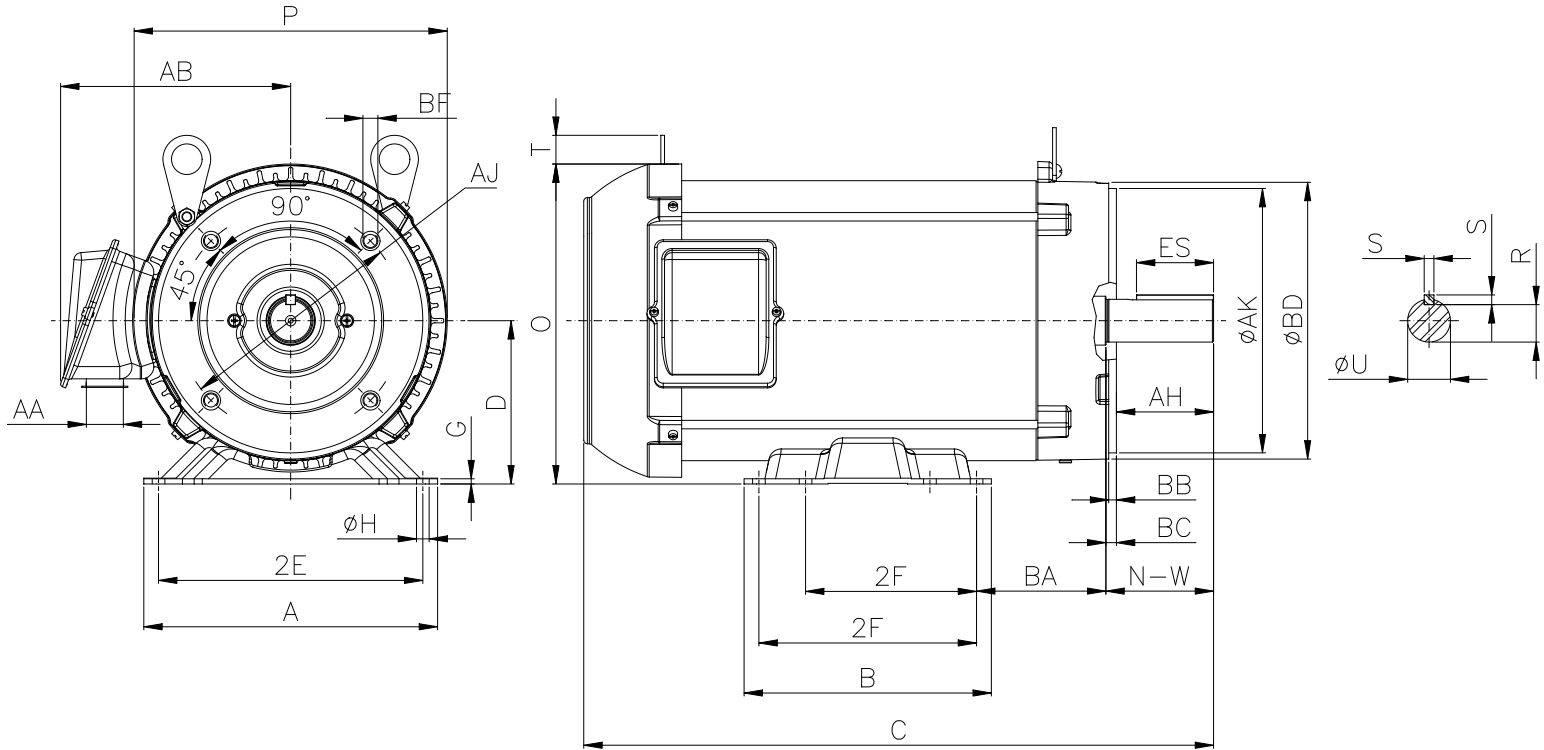

Notes: Downloaded from <http://dealerselectric.com>
Generated for Model #00112ET3ERS145TC

Performed by:

Checked:

Customer:

Three-Phase : Rolled Steel Motor - NEMA Premium Efficiency

2E 5.500	J 1.732	A 6.535	P 7.323	2F 4.000/5.000
K 2.25	B 6.496	BA 2.750	U 0.8750	N-W 2.250
ES 1.417	S 0.187	R 0.766	depth 0.187	D 3.500
O 7.165	T 0.237	H 0.343	C 14.095	FC 7.874
d1 A 4	d2 DM6	Flange FC-149	AJ 5.875	AK 4.500
BD 6.535	BF UNC 3/8"x16	BB 0.157	BC 9	

Three-phase induction motor
Frame 143/5T - IP55

12-SEP-2016

