

1 2 3 4 5 6 7 8

A

B

C

D

E

F

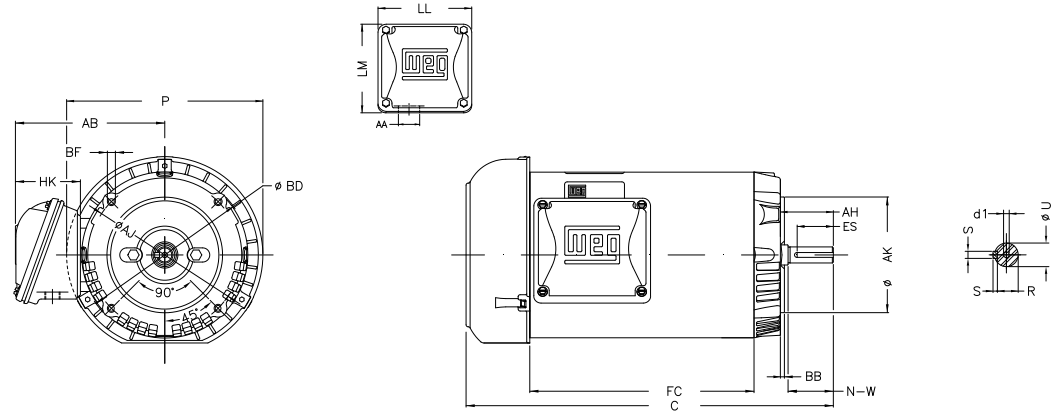

Notes: Downloaded from <http://dealerselectric.com>
Generated for Model #00112ET3E56CFL-S

Performed by:

Checked:

Customer:

Three-Phase: W01 (Rolled Steel) - TEFC - Premium Efficiency (DOE)

P	AB	HK	FC	C
7.638	5.882	2.638	7.874	13.504
N-W	ES	d1	S	U
1.874	1.417	A 3.15	0.187	0.625
AA	depth	R	LL	LM
0.881"	0.187	0.517	4.543	4.106
Flange	AJ	AK	BD	BF
FC-149	5.874	4.500	6.450	UNC 3/8"x16-2B
BB	AH			
0.157	2.062			

Three-phase induction motor
Frame 56 - IP55

12-SEP-2016

