

1 2 3 4 5 6 7 8

A

B

C

D

E

F

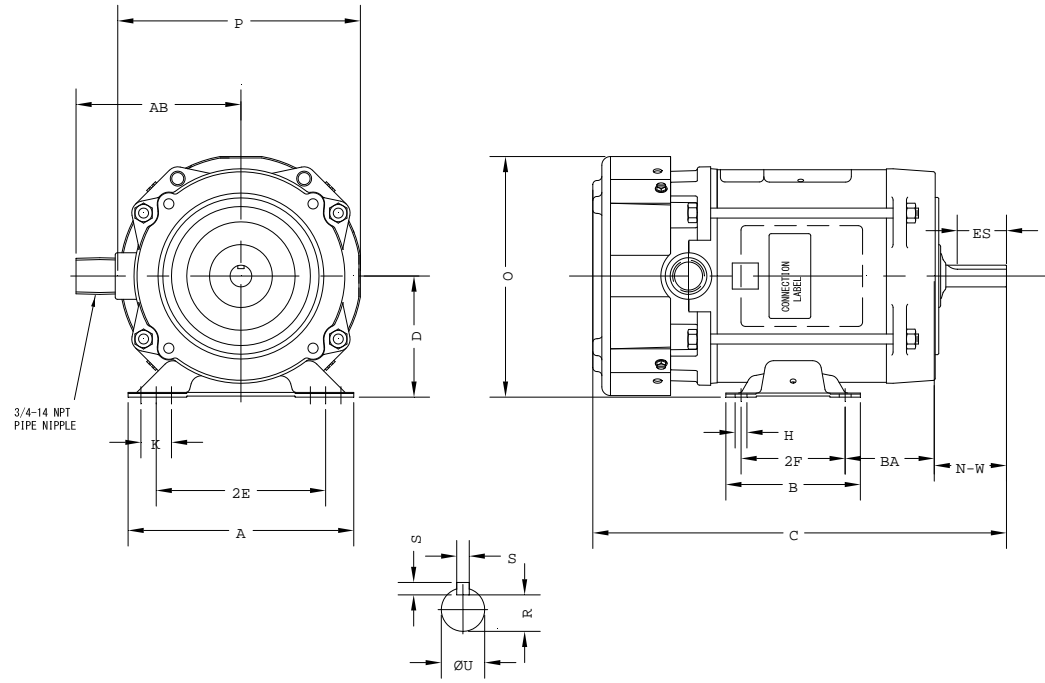

Notes: Downloaded from <http://dealerselectric.com>  
Generated for Model #.7536XS3E56

Performed by:

Checked:

Customer:

Three-Phase: Fractional Explosion Proof Motors

2E	A	P	B	BA
4.880	6.500	6.980	3.880	2.750
U	N-W	ES	S	R
0.6250	1.880	1.380	0.190	0.517
D	O	H	C	d1
3.500	6.920	0.340	11.790	SEM

Three-phase induction motor  
Frame 56 - IP55

12-SEP-2016

