

1 2 3 4 5 6 7 8

A

B

C

D

E

F

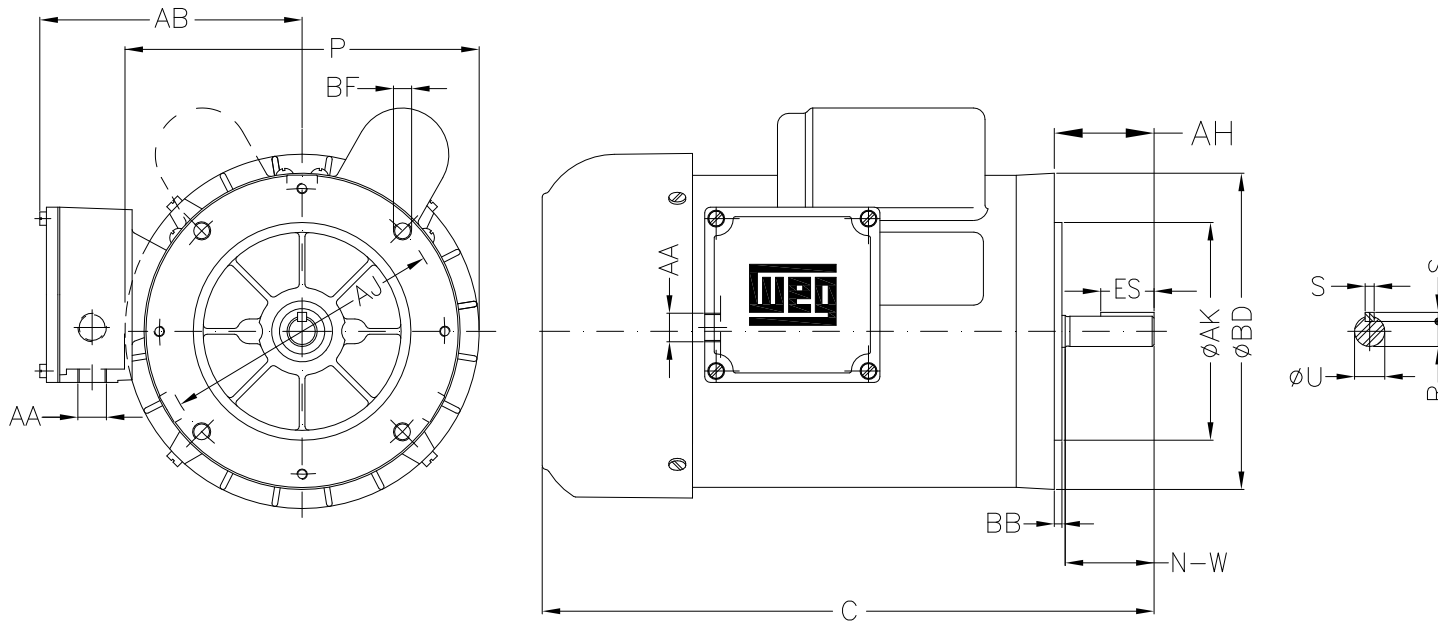

Notes: Downloaded from <http://dealerselectric.com>
Generated for Model #.7518ES1BB56CFL

Performed by:

Checked:

Customer:

Single-Phase : NEMA 56 TEFC

P	ES	S	depth	N-W
7.323	1.102	0.187	0.187	1.874
U	R	C	AA	Flange
0.6250	0.517	11.102	2xNPT 1/2"	FC-149
AJ	AK	BD	BF	BB
5.874	4.500	6.535	UNC 3/8"x16-2B	0.157
AH				
2.063				

Single-phase induction motor
Frame B56 - IP55

12-SEP-2016

