

1 2 3 4 5 6 7 8

A

B

C

D

E

F

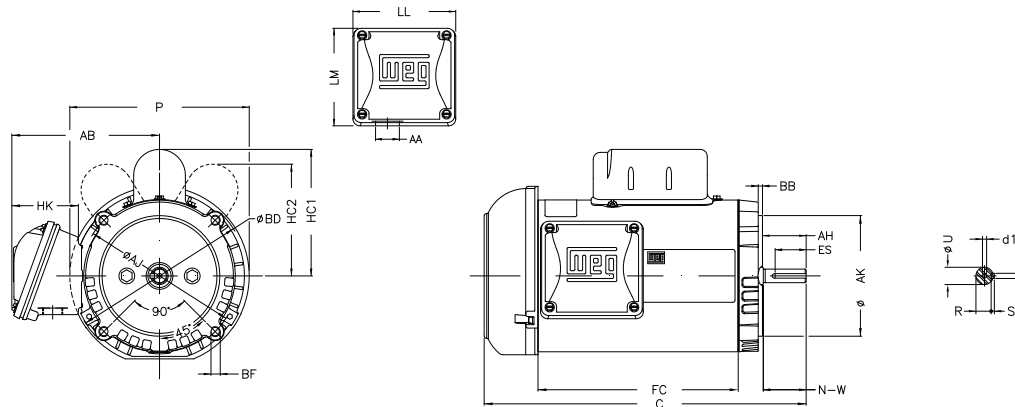

Notes: Downloaded from <http://dealerselectric.com>
Generated for Model #.5036ES1BW56CFL-S

Performed by:

Checked:

Customer:

Single Phase: W01 (Rolled Steel) - TEFC - Standard Efficiency

Single-phase induction motor
Frame W56 - IP55

12-SEP-2016



P 6.693	AB 5.520	HK 2.650	FC 6.693	C 11.500
N-W 1.874	ES 1.417	d1 A 3.15	S 0.187	U 0.625
AA 0.881"	depth 0.187	R 0.517	LL 3.835	LM 3.697
CH 1.417	HC1 4.717	Flange FC-149	AJ 5.874	AK 4.500
BD 6.470	BF UNC 3/8"x16-2B	BB 0.157	AH 2.063	