

1 2 3 4 5 6 7 8

A

B

C

D

E

F

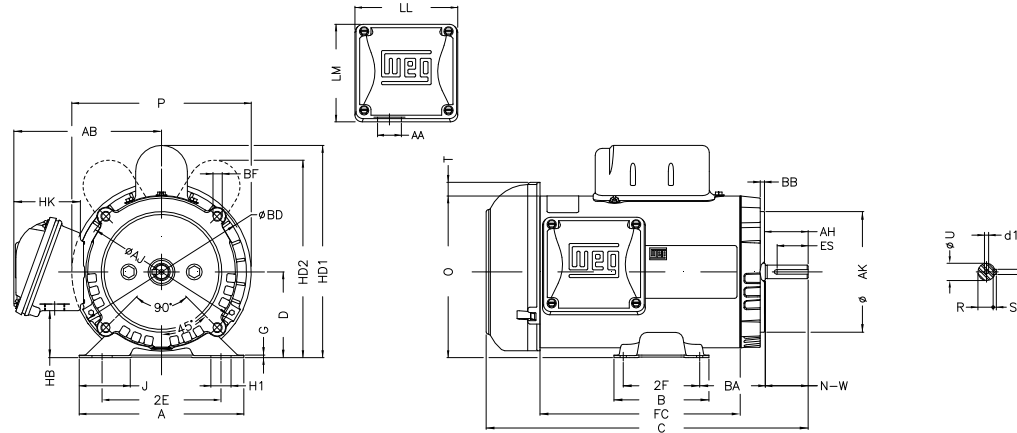

Notes: Downloaded from <http://dealerselectric.com>
Generated for Model #.5036ES1BW56C-S

Performed by:

Checked:

Customer:

Single Phase: W01 (Rolled Steel) - TEFC - Standard Efficiency

Single-phase induction motor
Frame W56 - IP55

12-SEP-2016



P	AB	J	2E	A
6.693	5.520	1.620	4.874	6.535
H	G	HB	HK	XO
0.343	0.075	2.055	2.650	0.524
O	FC	2F	B	C
6.330	6.693	3.000	4.016	11.500
BA	N-W	ES	d1	S
2.750	1.874	1.417	A 3,15	0.187
U	AA	depth	R	LL
0.625	0.881"	0.187	0.517	3.835
LM	D	CH	HD'	HC1
3.697	3.500	1.417	8.189	4.717
Flange	AJ	AK	BD	BF
FC-149	5.874	4.500	6.470	UNC 3/8"x16-2B
BB	AH			
0.157	2.063			