

1 2 3 4 5 6 7 8

A

B

C

D

E

F

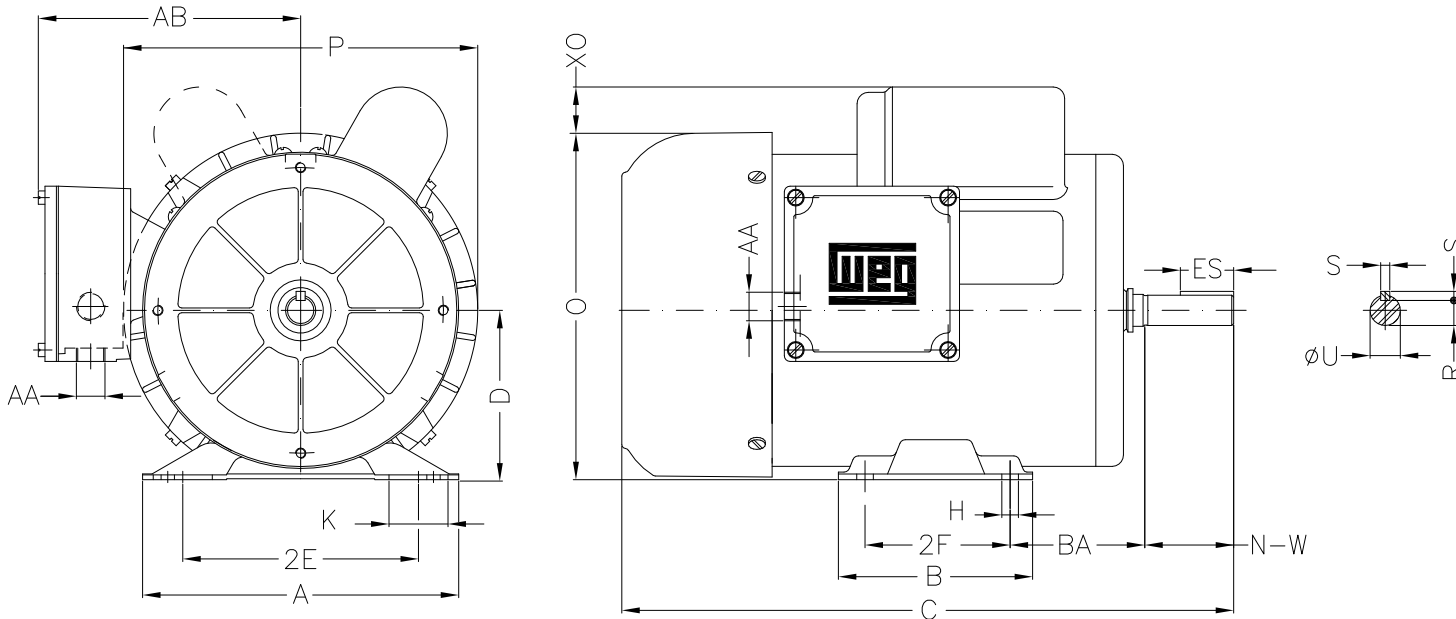

Notes: Downloaded from <http://dealerselectric.com>  
Generated for Model #.5018ES1BB56

Performed by:

Checked:

Customer:

Single-Phase : NEMA 56 TEFC

Single-phase induction motor  
Frame B56 - IP55

12-SEP-2016



2E 4.874	H 0.342	A 6.535	2F 3.000	B 4.016
BA 2.750	J 1.220	P 7.323	ES 1.102	S 0.187
depth 0.187	N-W 1.874	U 0.6250	R 0.517	D 3.500
O 7.165	XO 1.063	C 11.102	AA 2xNPT 1/2"	