

1 2 3 4 5 6 7 8

A

B

C

D

E

F

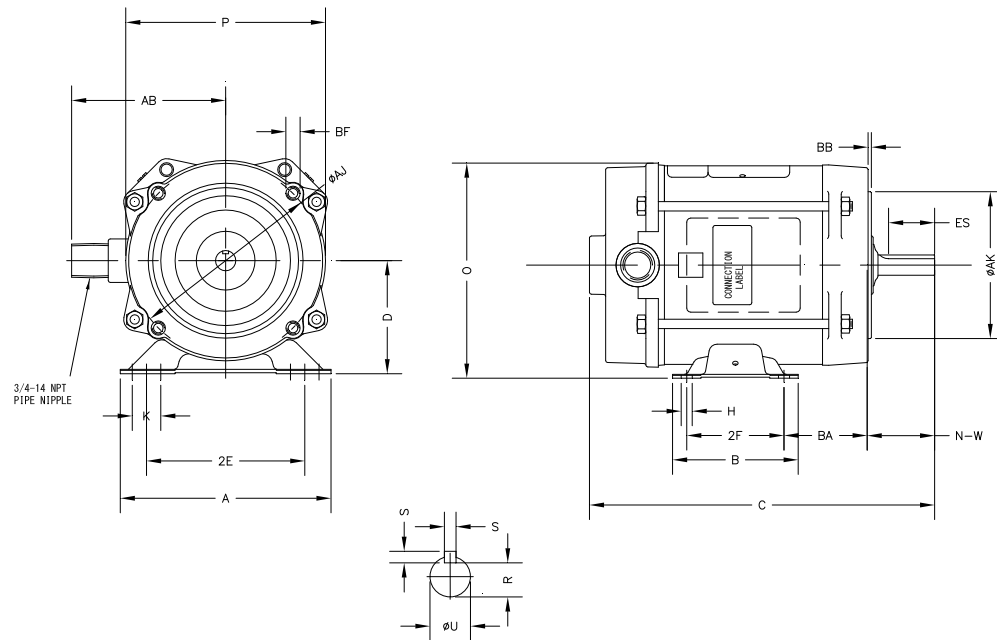

Notes: Downloaded from <http://dealerselectric.com>
Generated for Model #.3336XS3E56C

Performed by:

Checked:

Customer:

Three-Phase: Fractional Explosion Proof Motors

2E 4.880	A 6.500	P 6.980	B 3.880	BA 2.750
U 0.6250	N-W 1.880	ES 1.380	S 0.190	R 0.517
D 3.500	O 6.920	H 0.340	C 10.520	d1 SEM
Flange FC-149	AJ 5.880	AK 4.500	BD 6.000	BF UNC 3/8"x16-2B
BB 0.160	AH 2.060			

Three-phase induction motor
Frame 56 - IP55

12-SEP-2016

