

1 2 3 4 5 6 7 8

A
B
C
D
E
F

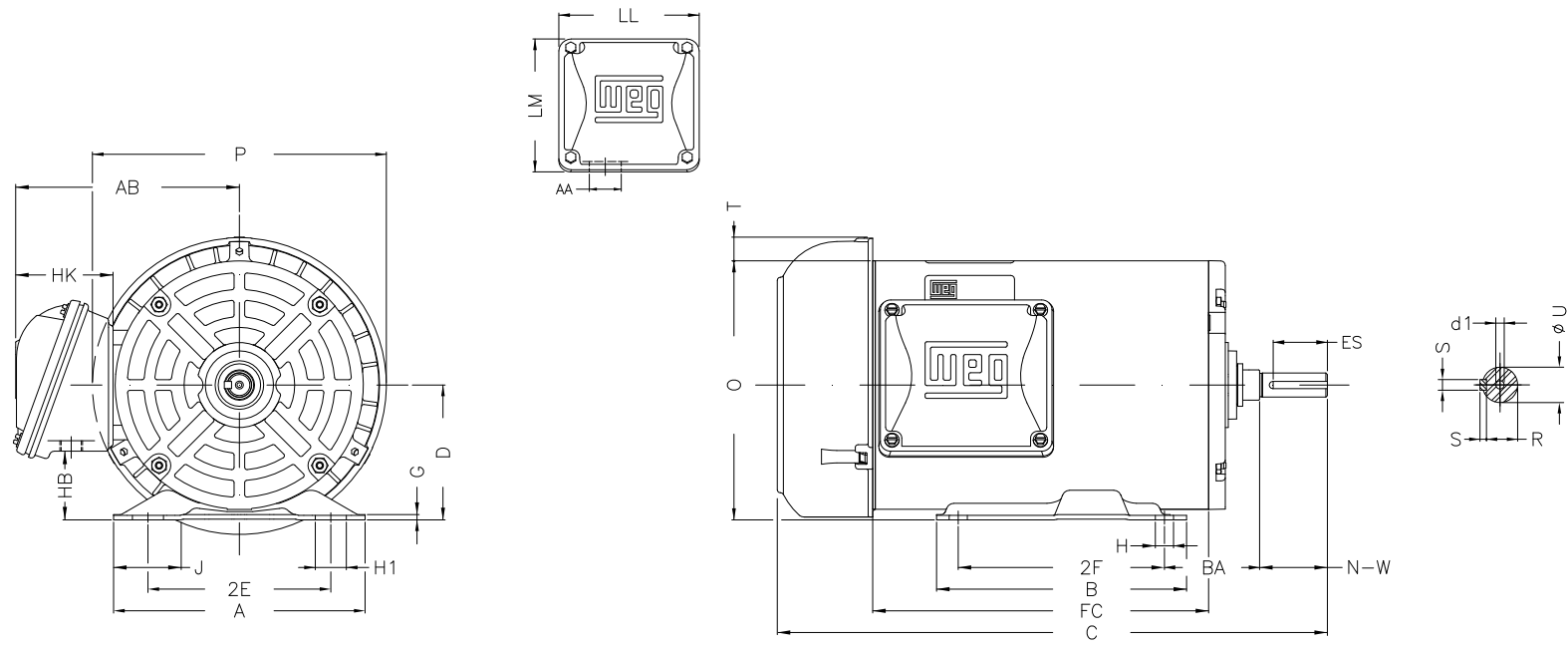

Notes: Downloaded from <http://dealerselectric.com>
Generated for Model #.3318ES3E56-S

Performed by:

Checked:

Customer:

Three Phase: W01 (Rolled Steel) - TEFC - Standard Efficiency

P	AB	J	2E	A
7.638	5.882	1.732	4.874	6.535
H	G	HB	HK	T
0.343	0.120	1.783	2.638	0.603
O	FC	2F	B	C
6.724	5.906	3.000	4.016	11.535
BA	N-W	ES	d1	S
2.750	1.874	1.417	A 3,15	0.187
U	AA	depth	R	LL
0.625	0.881"	0.187	0.517	4.543
LM	BB	D		
4.106	0.603	3.500		

Three-phase induction motor
Frame 56 - IP55

12-SEP-2016

