

1 2 3 4 5 6 7 8

A
B
C
D
E
F

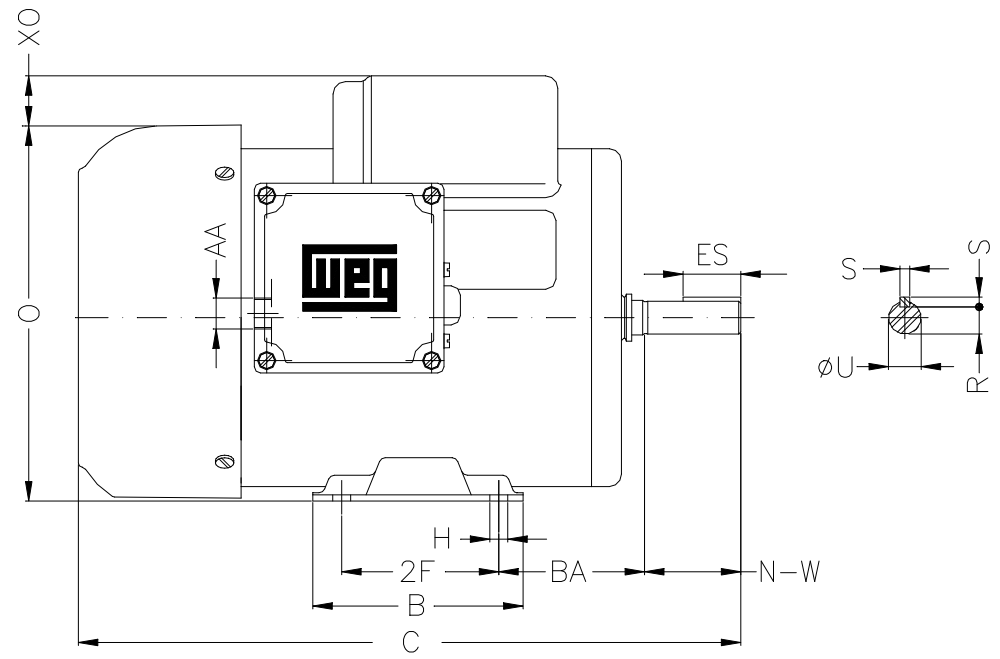
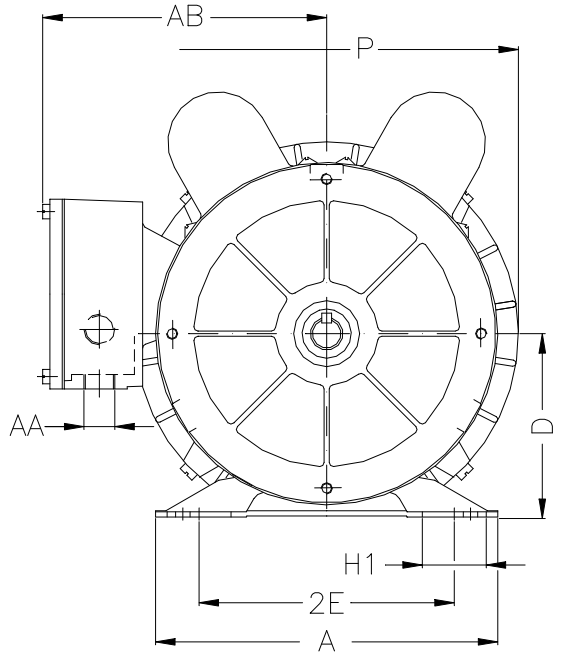

Notes: Downloaded from <http://dealerselectric.com>
Generated for Model #.3318ES1RFDB56

Performed by:

Checked:

Customer:

Farm Duty Motors : TEFC (IP55) - Single-Phase

2E 4.874	2F 3.000	H 0.342	BA 2.750	A 6.535
B 4.016	C 11.102	D 3.500	J 1.220	O 7.165
P 7.323	ES 1.102	S 0.187	N-W 1.874	U 0.6250
R 0.517	AB 5.433	AA 2xNPT 1/2"	d1 A 3.15	

Single-phase induction motor
Frame B56 - IP55

12-SEP-2016

