

1 2 3 4 5 6 7 8

| CATALOG # | TYPE | FRAME | OUTPUT |     | POLE | SYN. SPEED R.P.M. | VOLTAGE V. | HZ. | TIME RATING | INSULATION CLASS | SERVICE FACTOR | WEIGHT LBS |
|-----------|------|-------|--------|-----|------|-------------------|------------|-----|-------------|------------------|----------------|------------|
|           |      |       | HP     | KW  |      |                   |            |     |             |                  |                |            |
| WPV0012C  | AEGP | 143TC | 1      | .75 | 2    | 3600              | 230/460    | 60  | CONT.       | F                | 1.15           | 35         |

TOTALLY ENCLOSED FAN-COOLED TYPE. SQUIRREL CAGE MOTOR

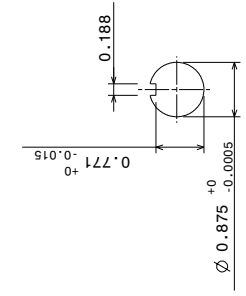
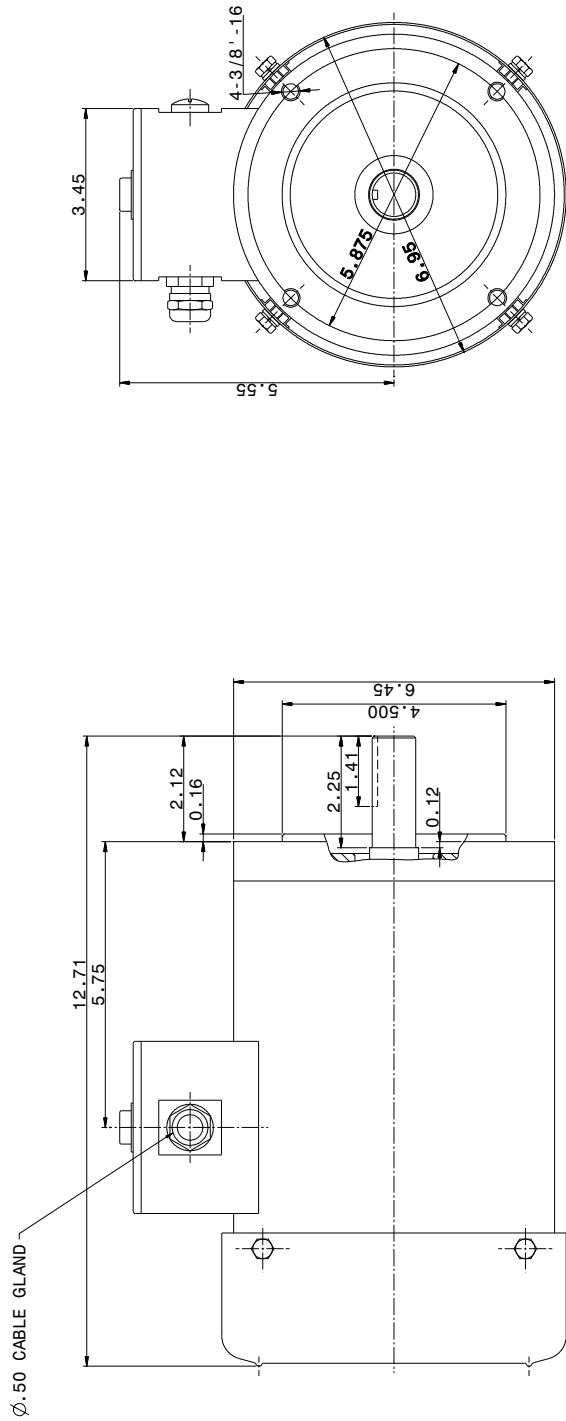

- NOTES:
1. DIMENSIONS IN INCH.
  2. ENCLOSURE: IP56.
  3. FOR DIRECT FLEXIBLE COUPLING.
  4. STAINLESS STEEL CONSTRUCTION.

|  |                   |                   |
|--|-------------------|-------------------|
| REV. DATA                                  | REV NO            | 01                |
|  | TECO Westinghouse |                   |
|  | DWG NO.           | WPV0012C          |
| 3-PHASE INDUCTION MOTOR OUTLINE DIMENSIONS |                   |                   |
| DRW. T. FELPS                              | APPD. S. GROHOSKY | 020713            |
| TECO-WESTINGHOUSE MOTOR COMPANY            |                   | ROUND ROCK, TEXAS |
| REF: 31049UB06230                          |                   | 020713            |
|  |                   | USA               |
|  |                   | APR REV A         |

1 2 3 4 5 6 7 8

# TECO Westinghouse

|                                |   |                             |
|--------------------------------|---|-----------------------------|
| ISSUED<br><b>April 4, 2013</b> | <b>PERFORMANCE DATA</b><br><b>3-PHASE INDUCTION MOTOR</b> | ENCLOSURE<br><b>TEFC</b>    |
| TYPE<br><b>AEGPVM</b>          |   | CATALOG#<br><b>WPV0012C</b> |

### NAMEPLATE INFORMATION

| OUTPUT     |             | POLE     | FRAME SIZE   | VOLTAGE        | HZ        | RATED AMBIENT | INS. CLASS | NEMA DESIGN | TIME RATING  | SERVICE FACTOR |
|------------|-------------|----------|--------------|----------------|-----------|---------------|------------|-------------|--------------|----------------|
| HP         | KW          |          |              |                |           |               |            |             |              |                |
| <b>1.0</b> | <b>0.75</b> | <b>2</b> | <b>143TC</b> | <b>230/460</b> | <b>60</b> | <b>40°C</b>   | <b>F</b>   | <b>B</b>    | <b>CONT.</b> | <b>1.15</b>    |

### TYPICAL PERFORMANCE

| FULL LOAD RPM | EFFICIENCY |           |            |            | POWER FACTOR |            |            | MAXIMUM POWER FACTOR CORRECTION |
|---------------|------------|-----------|------------|------------|--------------|------------|------------|---------------------------------|
|               | FULL LOAD  |           | 3/4 LOAD % | 1/2 LOAD % | F. L. %      | 3/4 LOAD % | 1/2 LOAD % |                                 |
|               | MIN. %     | NOM. %    |            |            |              |            |            |                                 |
| <b>3500</b>   | <b>77</b>  | <b>74</b> | <b>76</b>  | <b>73</b>  | <b>90</b>    | <b>86</b>  | <b>77</b>  | <b>1 KVAR</b>                   |

### CURRENTS

| NO LOAD     |             |             | FULL LOAD   |             |             | LOCKED ROTOR |              |              | NEMA KVA CODE LETTER |
|-------------|-------------|-------------|-------------|-------------|-------------|--------------|--------------|--------------|----------------------|
| AT          | AT          | AT          | AT          | AT          | AT          | AT           | AT           | AT           |                      |
| 208 VOLT    | 230 VOLT    | 460 VOLT    | 208 VOLT    | 230 VOLT    | 460 VOLT    | 208 VOLT     | 230 VOLT     | 460 VOLT     |                      |
| <b>1.55</b> | <b>1.40</b> | <b>0.70</b> | <b>2.90</b> | <b>2.80</b> | <b>1.40</b> | <b>33.17</b> | <b>30.00</b> | <b>15.00</b> | <b>N</b>             |

### TORQUE

### INERTIA

### ACCEL TIME

| FULL LOAD lb-ft | LOCKED ROTOR %FLT | PULL UP %FLT | BREAK DOWN %FLT | ROTOR WR <sup>2</sup> lb-ft <sup>2</sup> | NEMA LOAD WK <sup>2</sup> lb-ft <sup>2</sup> | MAX ALLOWABLE WK <sup>2</sup> lb-ft <sup>2</sup> | NEMA LOAD WK <sup>2</sup> Sec | MAX ALLOWABLE WK <sup>2</sup> Sec |
|-----------------|-------------------|--------------|-----------------|--|--|--|-------------------------------|-----------------------------------|
| <b>1.5</b>      | <b>250</b>        | <b>260</b>   | <b>300</b>      | <b>0.05933</b>                           | <b>1.100</b>                                 | <b>1.500</b>                                     | <b>3.51</b>                   | <b>4.73</b>                       |

| SAFE STALL TIME IN SECONDS |           | ALLOWABLE STARTS PER HOUR |          | SOUND PRESSURE LEVEL @ 3 FT dB(A) |
|----------------------------|-----------|---------------------------|----------|-----------------------------------|
| COLD                       | HOT       | COLD                      | HOT      |                                   |
| <b>12</b>                  | <b>10</b> | <b>2</b>                  | <b>1</b> |                                   |

|           |                  |             |                      |          |          |
|-----------|------------------|-------------|----------------------|----------|----------|
| APPROVED: | <b>M. PRATER</b> | DRAWING NO. | <b>31057WPV0012C</b> | REVISION | <b>0</b> |
|-----------|------------------|-------------|----------------------|----------|----------|

DATE:  
April 4, 2013

# CONNECTION DIAGRAM

CATALOG NO.:  
WPV0012C



## ACROSS THE LINE CONNECTION

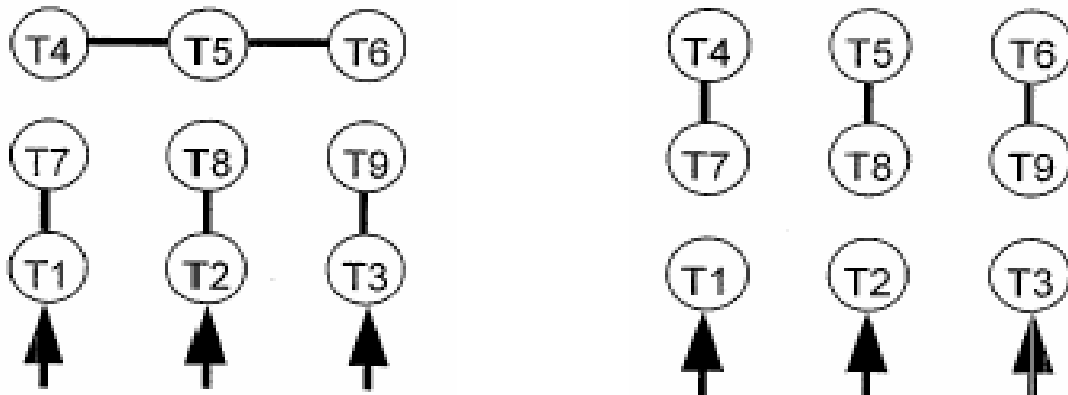

**LINE**  
**230 VOLT CONNECTION**

**LINE**  
**460 VOLT CONNECTION**



DWG NO.  
**DAC-1566-2**

# INSTALLATION AND MAINTENANCE INSTRUCTIONS FOR THREE PHASE INDUCTION MOTORS

Frames 143T - 449TZ



**TEC**  - Westinghouse 

M O T O R C O M P A N Y

## **RECEIVING**

1. Check nameplate data.
2. Check whether any damage has occurred during transportation.
3. Turn shaft by hand to check that it turns freely.
4. If motor is to be reshipped (alone or installed to another piece of equipment) the shaft must again be clamped to prevent axial movement.

Note: Remove the bearing clamp before turning the shaft of 284-T-445T frame motors.

## **WARNING**

### **THE FOLLOWING SAFETY PRECAUTIONS MUST BE OBSERVED:**

1. Electric rotating machinery and high voltage can cause serious or fatal injury if improperly installed, operated or maintained. Responsible personnel should be familiarized with NEMA MG2: Safety Standards for Construction and Guide for Selection. Installation and Use of Electric Motors and Generators; National Electric Code and all local safety requirements.
2. When servicing all power sources to the motor and to the accessory devices should be de-energized and disconnected and all rotating parts should be at standstill.
3. Lifting means, when supplied, are intended for lifting the motor only. When two lifting devices are supplied with the motor a dual chain must be used.
4. Suitable protection must be used when working near machinery with high noise levels.
5. Safeguard or protective devices must not be by-passed or rendered inoperative.
6. The frame of this machine must be grounded in accordance with the National Electrical Code and applicable local codes.
7. A suitable enclosure should be provided to prevent access to the motor by other than authorized personnel. Extra caution should be observed around motors that are automatically or have automatic resetting relays as they may restart unexpectedly.
8. Shaft key must be fully captive or remove before motor is started.

9. Provide proper safeguards for personnel against possible failure of motor-mounted brake, particularly on applications involving overhauling loads.
10. Explosion proof motors are constructed to comply with the label service procedure manual, repair of those motors must be made by TECO-WESTINGHOUSE or U/L listed service center in order to maintain U/L listing.

## LOCATION

1. Drip-proof motors are intended for use where atmosphere is relatively clean, dry, well ventilation and non-corrosive.
2. Totally enclosed motors may be installed where dirt, moisture, or dust present and in outdoor locations.
3. Explosion-proof motors are built for use in hazardous locations as indicated by Underwriters' label on the motor.
4. Chemical duty enclosed motors are design for installation in high corrosion or excessive moisture locations.

Note: in all cases, no surrounding structure should obstruct normal flow of ventilating air through or over the motor.

## MOUNTING

1. Mount motor securely on a firm, flat base. All ball bearing normal thrust motors up to and including 256T frame size, may be sidewall or ceiling mounted: all others, check nearest TECO-WESTINGHOUSE office for mounting recommendations.
2. Align motor accurately, using a flexible coupling if possible. For drive recommendations, consult with drive or equipment manufacturer, or TECO-WESTINGHOUSE.
3. Mounting bolts must be carefully tightened to prevent changes in alignment and possible damage to the equipment. The recommended tightening torques for medium carbon steel bolts, identified by three radial lines at 120 degrees on the head, are:

| Bolt Size | Recommended Torque(Ft-1b) |         |
|-----------|---------------------------|---------|
|           | Minimum                   | Maximun |
| 2/8       | 25                        | 37      |
| 1/2       | 60                        | 90      |
| 5/8       | 120                       | 180     |
| 3/4       | 210                       | 320     |

4. V-belt Sheave. Pitch Diameters should not be less than the following Table 1. values (NEMA recommended values).

table 1.V-belt sheave Pitch Diameters(MG1-14.42)

| Frame Number | Horsepower at          |         |       |       |
|--------------|------------------------|---------|-------|-------|
|              | Synchronous Speed. Rpm |         |       |       |
|              | 3600                   | 1800    | 1200  | 900   |
| 143T         | 1 1/2                  | 1       | 3/4   | 1/2   |
| 145T         | 2-3                    | 1 1/2-2 | 1     | 3/4   |
| 182T         | 3                      | 3       | 1 1/2 | 1     |
| 182T         | 5                      | ...     | ...   | ...   |
| 184T         | ...                    | ...     | 2     | 1 1/2 |
| 184T         | 5                      | ...     | ...   | ...   |
| 184T         | 7 1/2                  | 5       | ...   | ...   |
| 213T         | 7 1/2-10               | 7 1/2   | 3     | 2     |
| 215T         | 10                     | ...     | 5     | 3     |
| 215T         | 15                     | 10      | ...   | ...   |
| 254T         | 15                     | ...     | 7 1/2 | 5     |
| 254T         | 20                     | 15      | ...   | ...   |
| 256T         | 20-25                  | ...     | 10    | 7 1/2 |
| 256T         | ...                    | 20      | ...   | ...   |
| 284T         | ...                    | ...     | 15    | 10    |
| 284T         | ...                    | 25      | ...   | ...   |
| 286T         | ...                    | 30      | 20    | 15    |
| 324T         | ...                    | 40      | 25    | 20    |
| 326T         | ...                    | 50      | 30    | 25    |
| 364T         | ...                    | ...     | 40    | 30    |
| 364T         | ...                    | 60      | ...   | ...   |
| 365T         | ...                    | ...     | 50    | 40    |
| 365T         | ...                    | 75      | ...   | ...   |
| 404T         | ...                    | ...     | 60    | ...   |
| 404T         | ...                    | ...     | ...   | 50    |
| 404T         | ...                    | 100     | ...   | ...   |
| 405T         | ...                    | ...     | 75    | 60    |
| 405T         | ...                    | 100     | ...   | ...   |
| 405T         | ...                    | 125     | ...   | ...   |
| 444T         | ...                    | ...     | 100   | ...   |
| 444T         | ...                    | ...     | ...   | 75    |
| 444T         | ...                    | 125     | ...   | ...   |
| 444T         | ...                    | 150     | ...   | ...   |
| 445T         | ...                    | ...     | 125   | ...   |
| 445T         | ...                    | ...     | ...   | 100   |
| 445T         | ...                    | 150     | ...   | ...   |

\*Max. Sheave width = 2(N-W). 1/4"

\*\*Max. Sheave width = N.W.

\*Sheave ratios greater than 5:1 and center-to-center distance less than the diameter of the large sheave should be referred to the company

5. Tighten belts only enough to prevent slippage. Belt speed should not exceed 5000 ft. Per min.

| V bolt Sheave                 |                        |                                 |                           |
|-------------------------------|------------------------|---------------------------------|---------------------------|
| Conventional                  |                        | Narrow                          |                           |
| A.B.C.D. and E                |                        | 3V.5V.and 8V                    |                           |
| Minimum Pitch Diameter Inches | *Maximum Width. Inches | Minimum Outside Diameter Inches | **3 Maximum Width. Inches |
| 2.2                           | 4 1/4                  | 2.2                             | 2 1/4                     |
| 2.4                           | 4 1/4                  | 2.4                             | 2 1/4                     |
| 2.4                           | 5 1/4                  | 2.4                             | 2 3/4                     |
| 2.6                           | 5 1/4                  | 2.4                             | 2 3/4                     |
| 2.4                           | 5 1/4                  | 2.4                             | 2 3/4                     |
| 2.6                           | 5 1/4                  | 2.4                             | 2 3/4                     |
| 3.0                           | 5 1/4                  | 3.0                             | 2 3/4                     |
| 3.0                           | 6 1/2                  | 3.0                             | 3 3/8                     |
| 3.0                           | 6 1/2                  | 3.0                             | 3 3/8                     |
| 3.8                           | 6 1/2                  | 3.8                             | 3 3/8                     |
| 3.8                           | 7 3/4                  | 3.8                             | 4                         |
| 4.4                           | 7 3/4                  | 4.4                             | 4                         |
| 4.4                           | 7 3/4                  | 4.4                             | 4                         |
| 4.6                           | 7 3/4                  | 4.4                             | 4                         |
| 4.6                           | 9                      | 4.4                             | 4 5/8                     |
| 5.0                           | 9                      | 4.4                             | 4 5/8                     |
| 5.4                           | 9                      | 5.2                             | 4 5/8                     |
| 6.0                           | 10 1/4                 | 6.0                             | 5 1/4                     |
| 6.8                           | 10 1/4                 | 6.8                             | 5 1/4                     |
| 6.8                           | 11 1/2                 | 6.8                             | 5                         |
| 7.4                           | 11 1/2                 | 7.4                             | 5 7/8                     |
| 8.2                           | 11 1/2                 | 8.2                             | 5 7/8                     |
| 9.0                           | 11 1/2                 | 8.6                             | 5 7/8                     |
| 9.0                           | 14 1/4                 | 8.0                             | 7 1/4                     |
| 9.0                           | 14 1/4                 | 8.4                             | 7 1/4                     |
| 10.0                          | 14 1/4                 | 8.6                             | 7 1/4                     |
| 10.0                          | 14 1/4                 | 10.0                            | 7 1/4                     |
| 10.0                          | 14 1/4                 | 8.6                             | 7 1/4                     |
| 11.5                          | 14 1/4                 | 10.5                            | 7 1/4                     |
| 11.0                          | 16 3/4                 | 10.0                            | 8 1/2                     |
| 10.5                          | 16 3/4                 | 9.5                             | 8 1/2                     |
| 11.0                          | 16 3/4                 | 9.5                             | 8 1/2                     |
| ...                           | 16 3/4                 | 10.5                            | 8 1/2                     |
| 12.5                          | 16 3/4                 | 12.0                            | 8 1/2                     |
| 12.5                          | 16 3/4                 | 12.0                            | 8 1/2                     |
| ...                           | 16 3/4                 | 10.5                            | 8 1/2                     |



# POWER SUPPLY & CONNECTIONS.

1. Wiring of motor and control, overload protection and grounding should be in accordance with national electrical code and all, Local safety requirements.
2. Nameplate voltage and frequency should agree with power supply. Motor will operate satisfactorily on line voltage within 10% of nameplate value, or frequency within 5% combined variation not to exceed 10%. 230 Volt motors can be used on 208-volt network systems, but with slightly modified performance characteristics as shown on nameplate.
3. Dual voltage and single voltage motors can be connected for the desired voltage by following connection diagram shown on the nameplate or inside of the conduit box.
4. All Explosion Proof motors have Temperature Limiting Devices in the motor enclosure to prevent excessive external surface temperature of the motor in accordance with u/l standards. Terminals of thermal protectors (P1, P2) should be connected to the motor control equipment, according to the connection diagram inside of the conduit box.
5. Standard connection diagram for three phase, not thermally protected, dual rotation motors are shown as diagram A to E (Note: To change rotation. Interchange any two line leads)

## A.3 Leads, Single Voltage

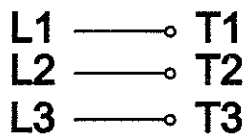

## B.6 Leads, Dual Voltage & Voltage Ratio 1to $\sqrt{3}$

### B-1. Across The Line Start & Run

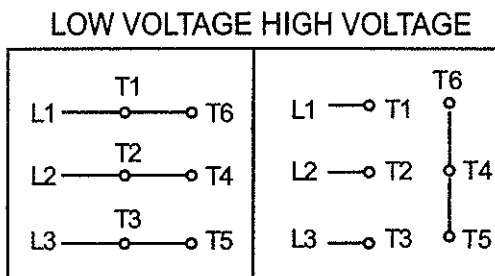

### B-2. Wye Start & Delta Run (Low Voltage only)

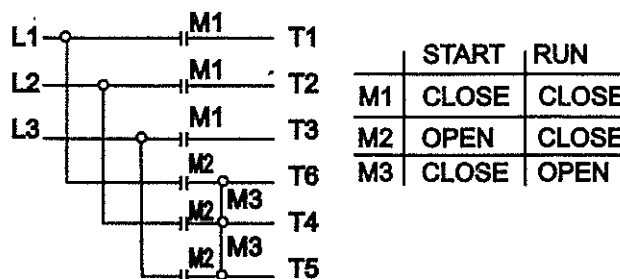

C.9 lead, Dual Voltage & Voltage Ratio 1 to 2. Wye connected.

C-1. Across The Line Start & Run

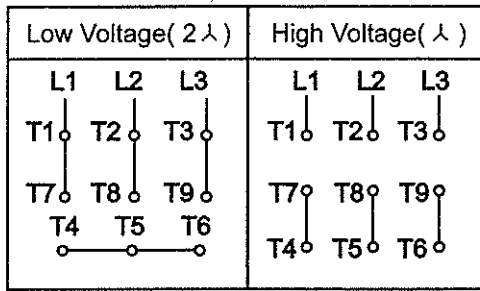

C-2. Part Winding Start (Low Voltage only)

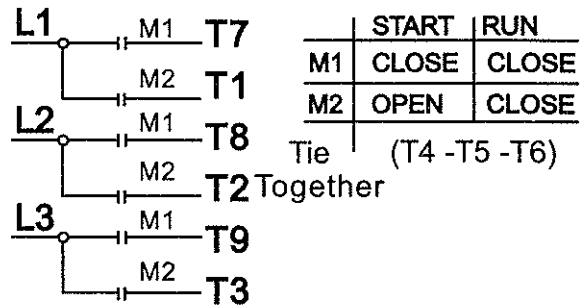

D.9 lead, Dual Voltage & Voltage Ratio 1 to 2. Delta connected.

D-1. Across The Line Start & Run

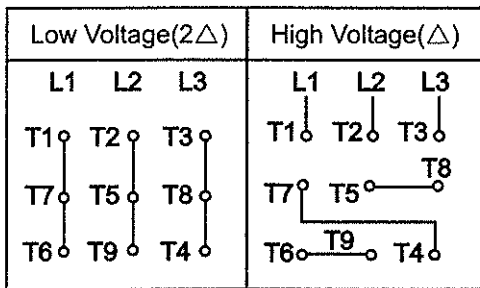

D-2. Part Winding Start (Low Voltage only)

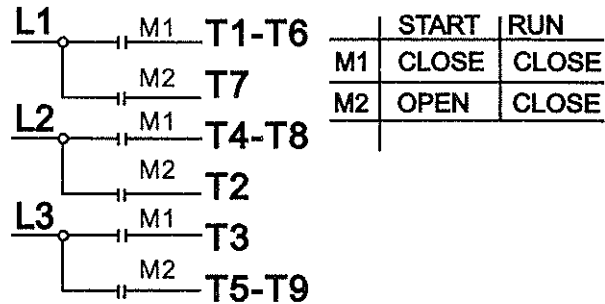

E.12 Leads, Dual Voltage

E-1. Across The Line Start & Run

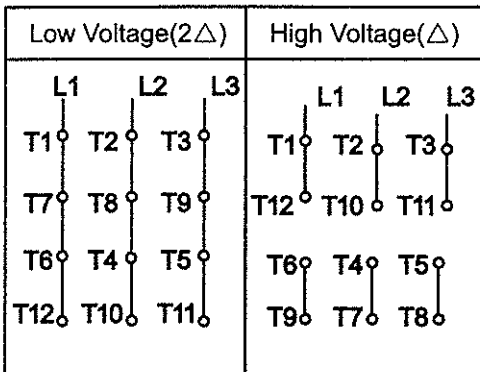

E-2. Wye Start & Delta Run

E-2-1. Low Voltage

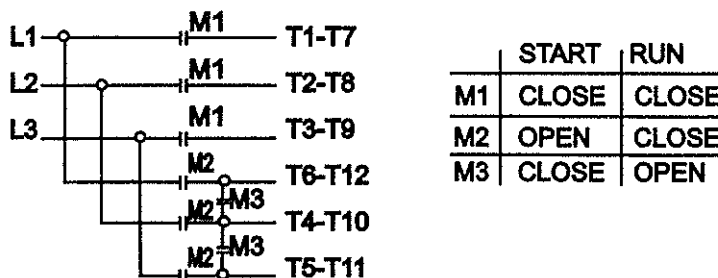

## E-2-2. High Voltage

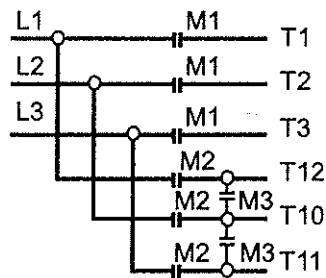

|    | START | RUN   |
|----|-------|-------|
| M1 | CLOSE | CLOSE |
| M2 | OPEN  | CLOSE |
| M3 | CLOSE | OPEN  |

Tie Together(T4-T7),(T5-T8),(T6-T9)

## E-3.Part Winding Start(Low Voltage only)

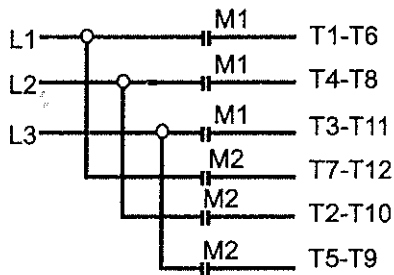

|    | START | RUN   |
|----|-------|-------|
| M1 | CLOSE | CLOSE |
| M2 | OPEN  | CLOSE |

\* Important: For Part Winding Start, M2 contactor should be closed within two (2)seconds after M1 contactor is closed.

\* Only 4 poles and above (e. g. 6p, 8P...) Motors are satisfactory for part winding start at low voltage.

## START UP

1. Disconnect load and start motor. Check direction of rotation. If rotation must be changed, ALLOW THE MOTOR TO STOP COMPLETELY. Interchange any two leads of a three phase motor.
2. Connect load. The motor should start quickly and run smoothly. If not, shut power off at once. Recheck the assembly including all connections before restarting.
3. If excessive vibration is noted, check for loose mounting bolts, too flexible motor support structure or transmitted vibration from adjacent machinery. Periodic vibration checks should be made, foundations often settle
4. Operate under load for short period of time; check operating current against nameplate.

# TESTING

If the motor has been in storage for an extensive period or has been subjected to adverse moisture conditions, it is best to check the insulation resistance of the stator winding with a megohmmeter. Depending on the length and conditions of storage it may be necessary to regrease or change rusted bearings.

If the resistance is lower than one megohm the windings should be dried in one of the two following ways;

- 1) Bake in oven at temperatures not exceeding 194 degree F until insulation resistance becomes constant.
- 2) With rotor locked, apply low voltage and gradually increase current through windings until temperature measured with thermometer reaches 194 degree F. Do not exceed this temperature.

# MAINTENANCE INSPECTION

Inspect motor at regular intervals. Keep motor clean and ventilation openings clear.

# LUBRICATION

- 1 Frame 143T-256T: Double shield and prelubricated ball-bearing motors without grease fittings and don't need relubrication.
- 2 Frame 280TS, 320-445T&S: motors having grease fittings and grease discharge devices at brackets. Motors are shipped with grease for initial running. It is necessary to relubricate anti-friction bearing motors periodically, depending on size and type of service, (see table 2) to provide maximum bearing life. Excessive or too frequent lubrication may damage the motor.

**TABLE 2**

| Horsepower  |                        | Standard Conditions | Severe Conditions | Extreme Conditions |
|-------------|------------------------|---------------------|-------------------|--------------------|
| 1 THRU 40   | 30.1800 rpm and below  | 7 years             | 3 years           | 6 months           |
| 40 THRU 100 | 75.1800 rpm and below  | 210 days            | 70 days           | 30 days            |
| 100 THRU 1  | 150.1800 rpm and below | 90 days             | 30 days           | 15 days            |
| 1 THRU 25   | 20.3600 rpm            | 5 years             | 2 years           | 3 months           |
| 25 THRU 100 | 75.3600 rpm            | 180 days            | 60 days           | 30 days            |
| 100 THRU    | 150.3600 rpm           | 90 days             | 30 days           | 15 days            |

- Note: 1). Standard conditions: 8 hours operation per day, normal or light loading, clear and 40 degree C ambient conditions.
- 2). Severe conditions: 24 hours operation per day or light shock loading, vibration or in dirt or dust conditions.
- 3). Extreme conditions: With heavy shock or vibration or dust conditions.
- 4). For double shield bearing, above data (lubrication frequency) mean that the bearing must be replaced.
3. Be sure fittings are clean and free from dirt. Using a low-pressure grease gun, pump in the recommended grease until new grease appears at grease discharge hole.
4. Use the ALVANIA R3 grease or equivalent lithium based grease unless a special grease is specified on the nameplate.
5. If relubrication is to be performed with the motor running, stay clear of rotating parts, After regreasing, allow the motor to run for ten to thirty minutes.

## **RENEWAL PARTS:**

- 1 Use only genuine TECO-WESTINGHOUSE renewal parts or as recommended by TECO-WESTINGHOUSE.
2. When you order renewal parts please specify complete information to TECO-WESTINGHOUSE. Office/agent such as type, frame NO., poles, horsepower series NO., quantity, etc.

## **FOR FURTHER INFORMATION PLEASE CONTACT TECO-WESTINGHOUSE MOTOR COMPANY**

**SALES OFFICE:** Houston, TX (713) 864-5980  
Los Angeles, CA (714) 670-2722  
Spartanburg, SC (864) 576-0356  
Allentown, PA (610) 391-9690  
Portland, OR (503) 684-3363

**HEAD QUARTER:** Round Rock, TX (512) 255-4141

Printed in China

**STANDARD WARRANTY FOR TECO-WESTINGHOUSE MOTORS ALL TECO-WESTINGHOUSE brand motors sold by TECO-WESTINGHOUSE MOTOR COMPANY are warranted to be free from defects in material and workmanship for a period of 36 months from the date of manufacture..**

**This warranty is conditioned upon the installation, operation, and maintenance of the motors in accordance with TECO-WESTING HOUSE MOTOR COMPANY's recommendations or standard industry practice and the motors have at all times being operated or used under normal operating conditions for which they were designed.**

**TECO-WESTINGHOUSE MOTOR COMPANY shall, at its sole option and expense, either repair or replace, F.O.B. warehouse, any such motor or part which is defective within the warranty period.**

**In the event of warranty claims. TECO-WESTINGHOUSE MOTOR COMPANY must be notified promptly following any motor failure. The motor shall be sent to a TECO-WESTINGHOUSE MOTOR COMPANY authorized service center for diagnosis on the cause of failure. If the failure is due to defective material and/or workmanship, TECO-WESTINGHOUSE MOTOR COMPANY will replace or repair the defective motor or part.**

**The repair or replacement of defective material and workmanship shall constitute complete fulfillment of TECO-WESTINGHOUSE MOTOR COMPANY's warranty liability whether the warranty claims are based on contract, tort (including negligence and strict liability), or otherwise.**

**THERE ARE NO OTHER WARRANTIES, EXPRESS OR IMPLIED, INCLUDING ANY IMPLIED WARRANTY OF MERCHANTABILITY AND FITNESS FOR PARTICULAR PURPOSE, AND ALL WARRANTIES ARISING FROM COURSE OF DEALING AND USAGE OF TRADE.**

**UNDER NO CIRCUMSTANCES, SHALL TECO-WESTINGHOUSE MOTOR COMPANY BE LIABLE FOR ANY SPECIAL, INDIRECT INCIDENTAL, OR CONSEQUENTIAL DAMAGES, INCLUDING FREIGHT**