

DATE
March 5, 2007
Cat. #: XV0504C

OUTLINE DIMENSIONS

3-PHASE INDUCTION MOTOR

MOTOR TYPE:
AEUHXF
FRAME NO. 326TC

Pole	HP	kW	Hz	VOLT	Syn. Speed r/min(rpm)
4	50	37	60	230/460	1800

Ins	Rating	Dimension in	Approx Weight	Bearings
F	CONT.	inch	781 lbs	DE: 6312 NDE: 6212

Totally Enclosed Fan Cooled Type. Squirrel-cage Rotor.

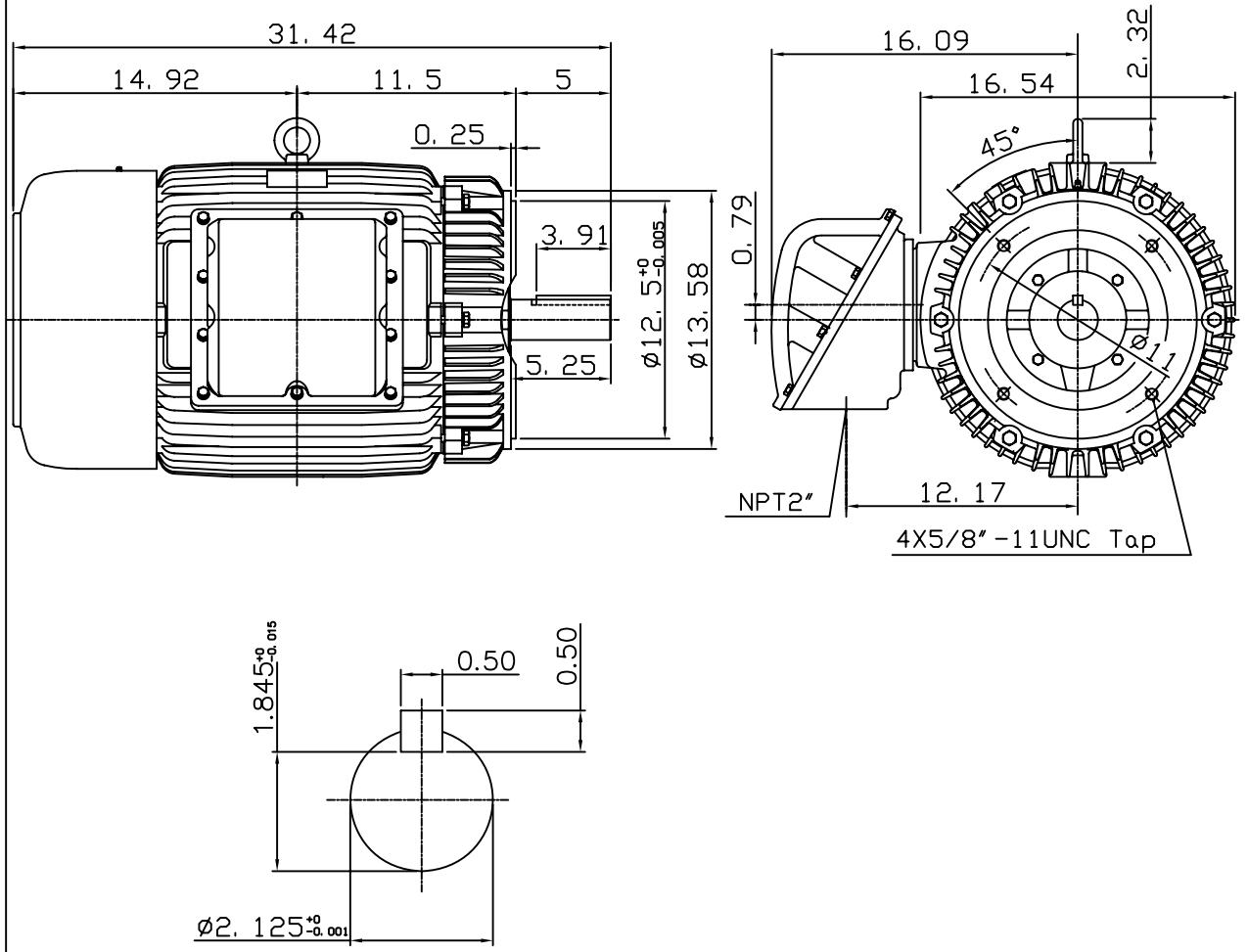

Note:
1. Suitable for division I,
class I Group D & class II
Group E, F, G, T2D or T3B.

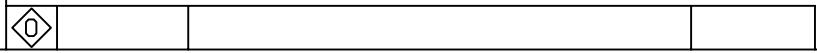

DWN.	G. L. GUO	03-31-03
CHKD.	C. H. KAO	04-01-03
APPD.	Y. B. HUANG	04-01-03



DWG NO.
31049U564000