

DATE
MAY 3, 2004
CATALOG NO.
XV0254C

OUTLINE DIMENSIONS
3-PHASE INDUCTION MOTOR

MOTOR TYPE:
AEUHXF
FRAME NO. 284TC

Pole	HP	KW	Hz	VOLT	Syn. Speed RPM
4	25	18.65	60	230/460	1800

Ins	Rating	Dimension in	Approx Weight	Bearings
F	CONT.	inches	512 lbs.	DE: 6311ZZ NDE: 6310ZZ

Totally Enclosed Fan Cooled Type. Squirrel-cage Rotor.

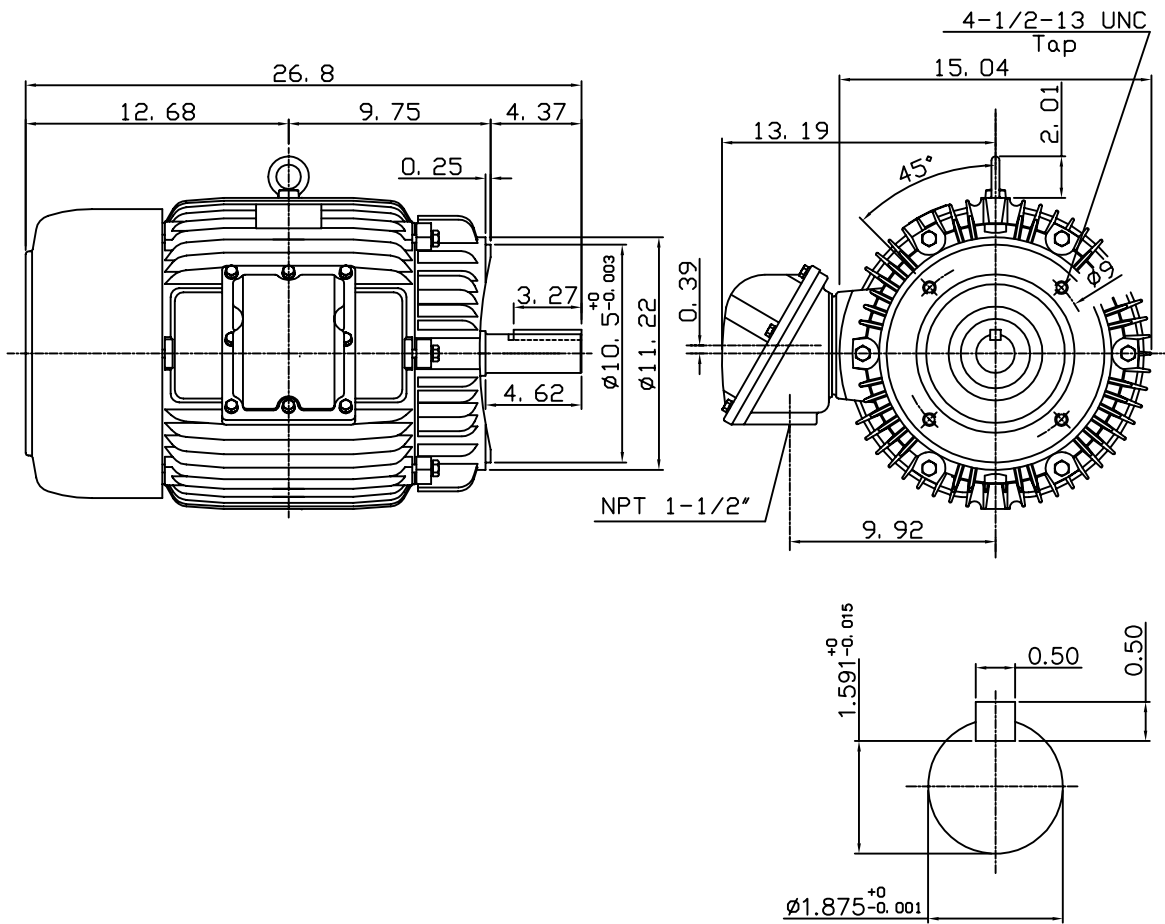

NOTE:
1. EXPLOSION-PROOF:
CLASS I GROUP D AND
CLASS II GROUP E,F,G.



DWN.	J. H. LIANG	11-30-98
CHKD.	C. H. KAO	12-26-98
APPD.	Y. B. HUANG	12-26-98

TECO Westinghouse

DWG NO.
31049U558001