

DATE  
MAY 3, 2004  
CATALOG NO.  
XV0156C

OUTLINE DIMENSIONS  
3-PHASE INDUCTION MOTOR

MOTOR TYPE:  
AEUHXF  
FRAME NO. 284TC

Pole	HP	KW	Hz	VOLT	Syn. Speed RPM
6	15	11.2	60	230/460	1200
Ins	Rating	Dimension in	Approx Weight	Bearings	
F	CONT.	inches	512 lbs.	DE: 6311ZZ	NDE: 6310ZZ

Totally Enclosed Fan Cooled Type. Squirrel-cage Rotor.

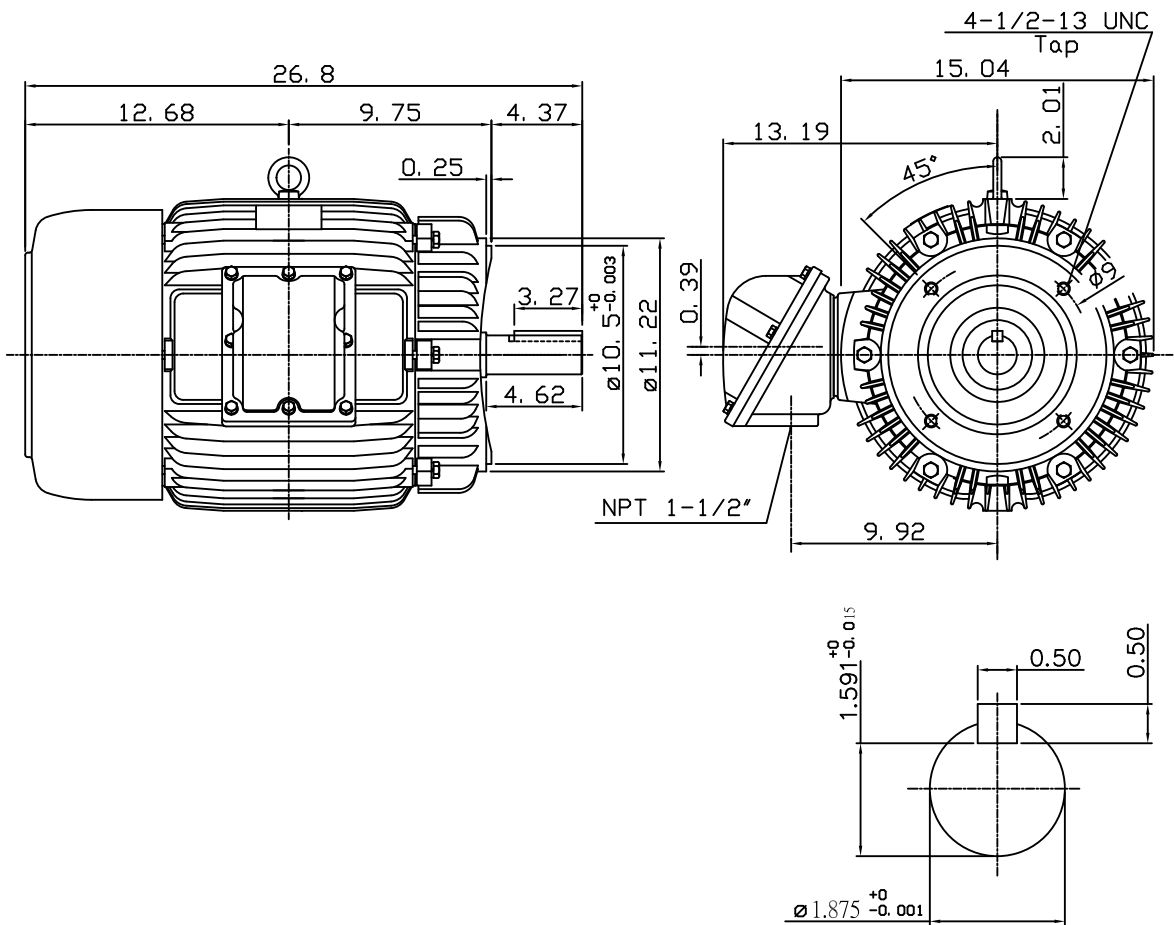

NOTE:  
1. EXPLOSION-PROOF:  
CLASS I GROUP D AND  
CLASS II GROUP E,F,G.

DWN.	J. H. LIANG	11-30-98
CHKD.	C. H. KAO	12-26-98
APPD.	Y. B. HUANG	12-26-98

TECO Westinghouse

DWG NO.  
31049U558000