

DATE  
MAY 18, 2011  
CATALOG NO.  
XPO156

OUTLINE DIMENSIONS  
3-PHASE INDUCTION MOTOR

MOTOR TYPE:  
AEHHXU  
FRAME NO. 284T

Pole	HP	KW	Hz	VOLT	Syn. Speed RPM
6	15	11.2	60	230/460	1200

Ins	Rating	Dimension in	Approx Weight	Bearings
F	CONT.	inches	488 lbs.	DE: 6311ZZ NDE: 6310ZZ

Totally Enclosed Fan Cooled Type. Squirrel-cage Rotor.

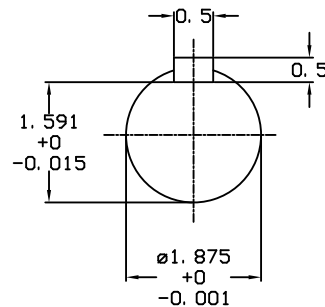
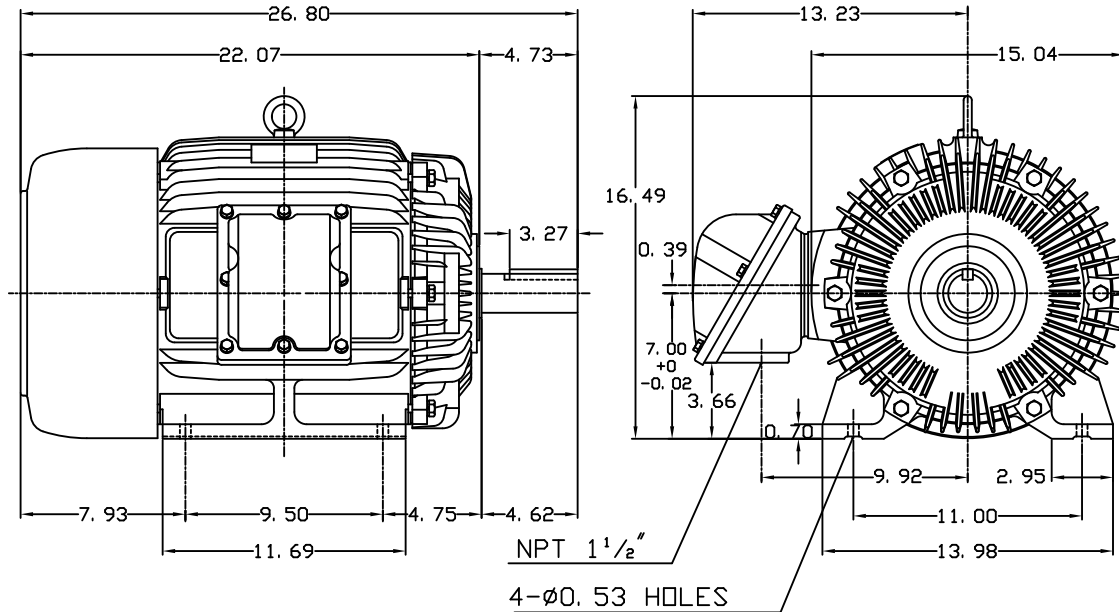

NOTE:  
1. EXPLOSION-PROOF:  
CLASS I GROUP C, D AND  
CLASS II GROUP E, F, G.



DWN.	J. H. LIANG	11-30-98
CHKD.	C. H. KAO	12-26-98
APPD.	Y. B. HUANG	12-26-98

TECO Westinghouse

DWG NO.  
31049M627101