

DATE  
MAY 18, 2011  
CATALOG NO.  
XP0154

OUTLINE DIMENSIONS  
3-PHASE INDUCTION MOTOR

MOTOR TYPE:  
AEHHXU  
FRAME NO. 254T

Pole	HP	KW	Hz	VOLT	Syn. Speed RPM
4	15	11.2	60	230/460	1800

Ins	Rating	Dimension in	Approx Weight	Bearings	
F	CONT.	inches	330 lbs.	DE: 6309ZZ	NDE: 6307ZZ

Totally Enclosed Fan-Cooled Type, Squirrel-Cage Rotor.

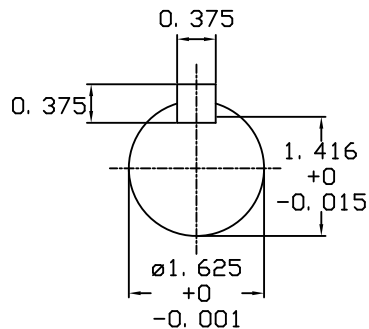
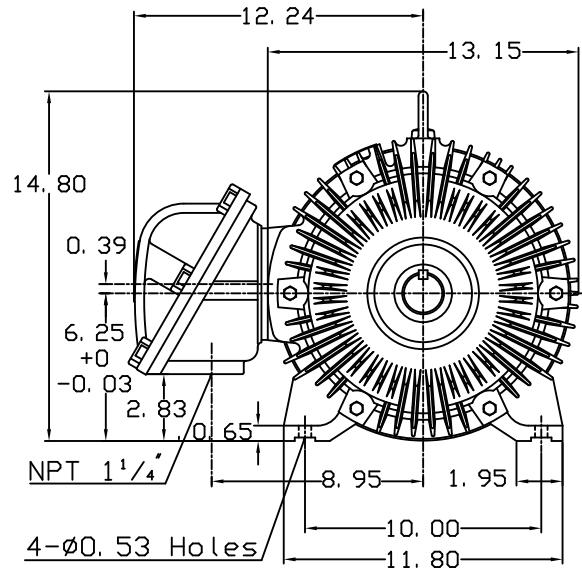
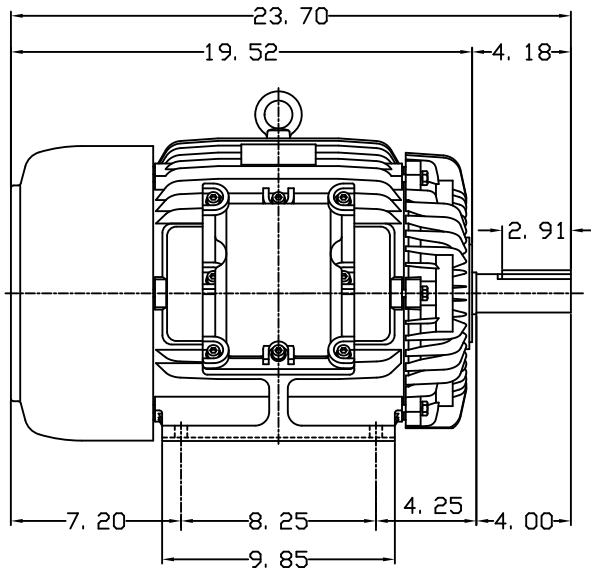

NOTE:

- EXPLOSION PROOF:  
CLASS I GROUP C, D AND  
CLASS II GROUP E, F, G.



DWN.	J. H. LIANG	12-04-98
CHKD.	C. S. LO	12-10-98
APPD.	Y. B. HUANG	12-10-98

TECO Westinghouse

DWG NO.  
31049M625212