

DATE
MAY 18, 2011
CATALOG NO.
XP0106

OUTLINE DIMENSIONS
3-PHASE INDUCTION MOTOR

MOTOR TYPE:
AEHHXU
FRAME NO. 256T

Pole	HP	KW	Hz	VOLT	Syn. Speed RPM
6	10	7.5	60	230/460	1200
Ins	Rating	Dimension in	Approx Weight	Bearings	
F	CONT.	inches	376 lbs.	DE: 6309ZZ	NDE: 6307ZZ

Totally Enclosed Fan-Cooled Type, Squirrel-Cage Rotor.

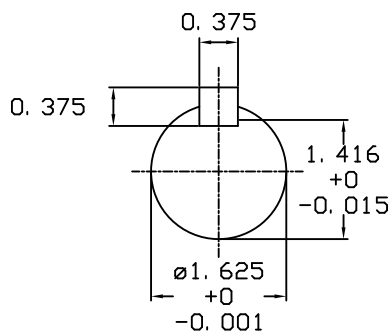
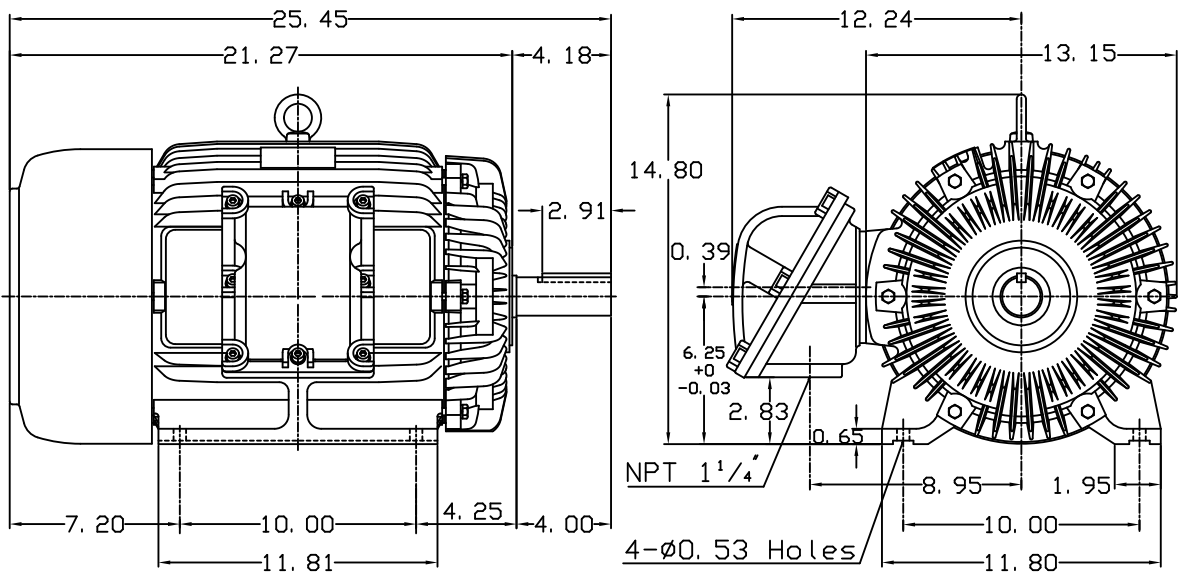

NOTE:

- EXPLOSION PROOF:
CLASS I GROUP C, D AND
CLASS II GROUP E, F, G.



DWN.	J. H. LIANG	12-04-98
CHKD.	C. S. LO	12-10-98
APPD.	Y. B. HUANG	12-10-98

TECO Westinghouse

DWG NO.
31049M626140