

CATALOG #	TYPE	FRAME	OUTPUT		POLE	SYN. SPEED R.P.M.	VOLTAGE V.	Hz.	TIME RATING	INSULATION CLASS	SERVICE FACTOR	WEIGHT LBS
			HP	KW								
WPV0034C	AEGP	182TC	3	2.24	4	1800	230/460	60	CONT.	F	1.15	81 LBS.

TOTALLY ENCLOSED FAN-COOLED TYPE. SQUIRREL CAGE MOTOR

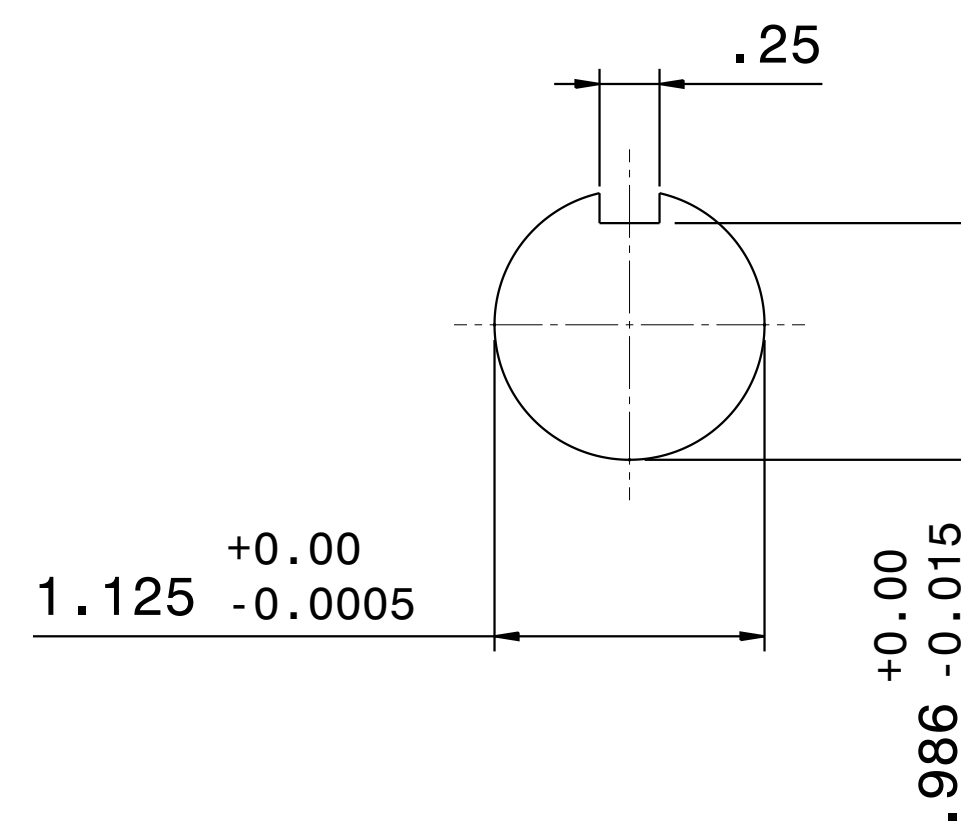
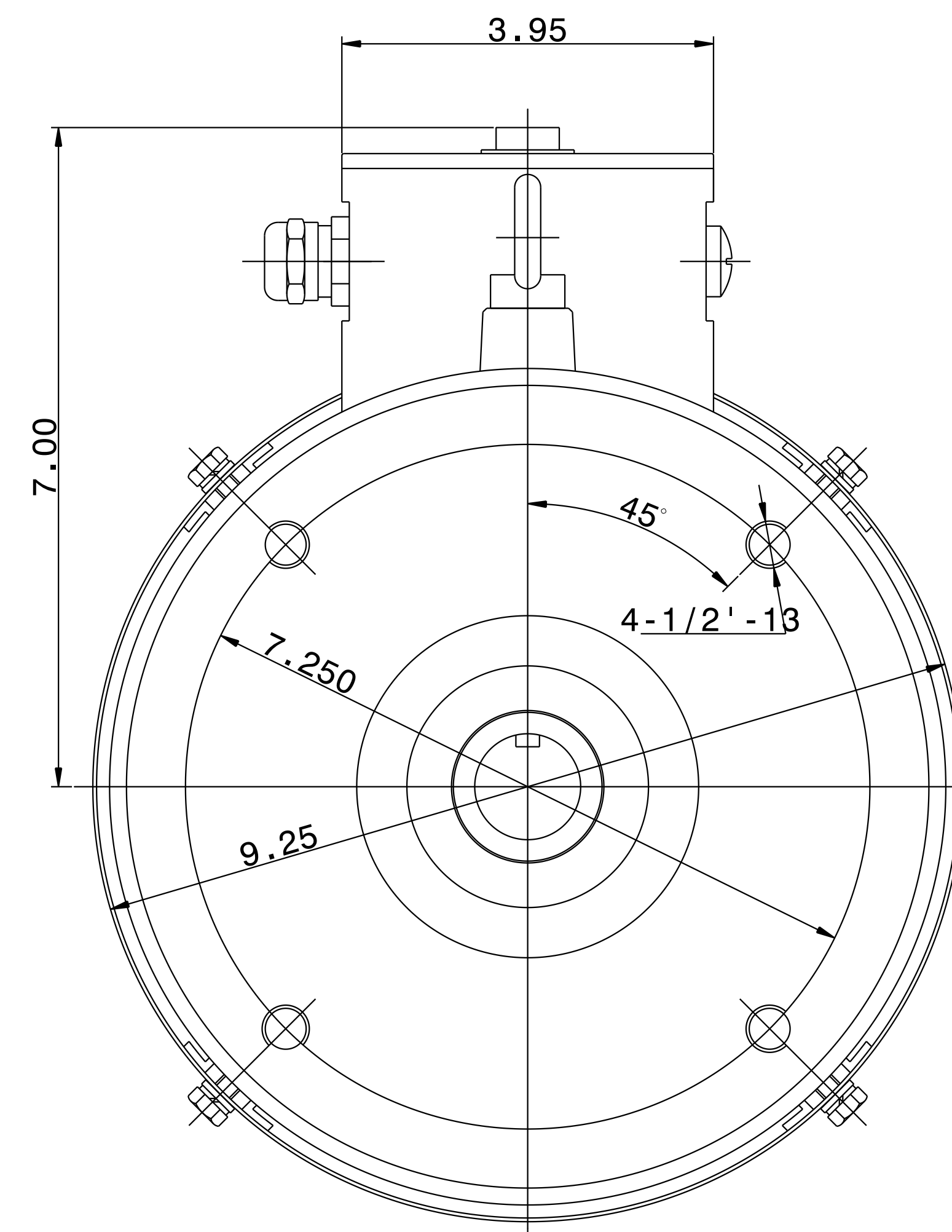
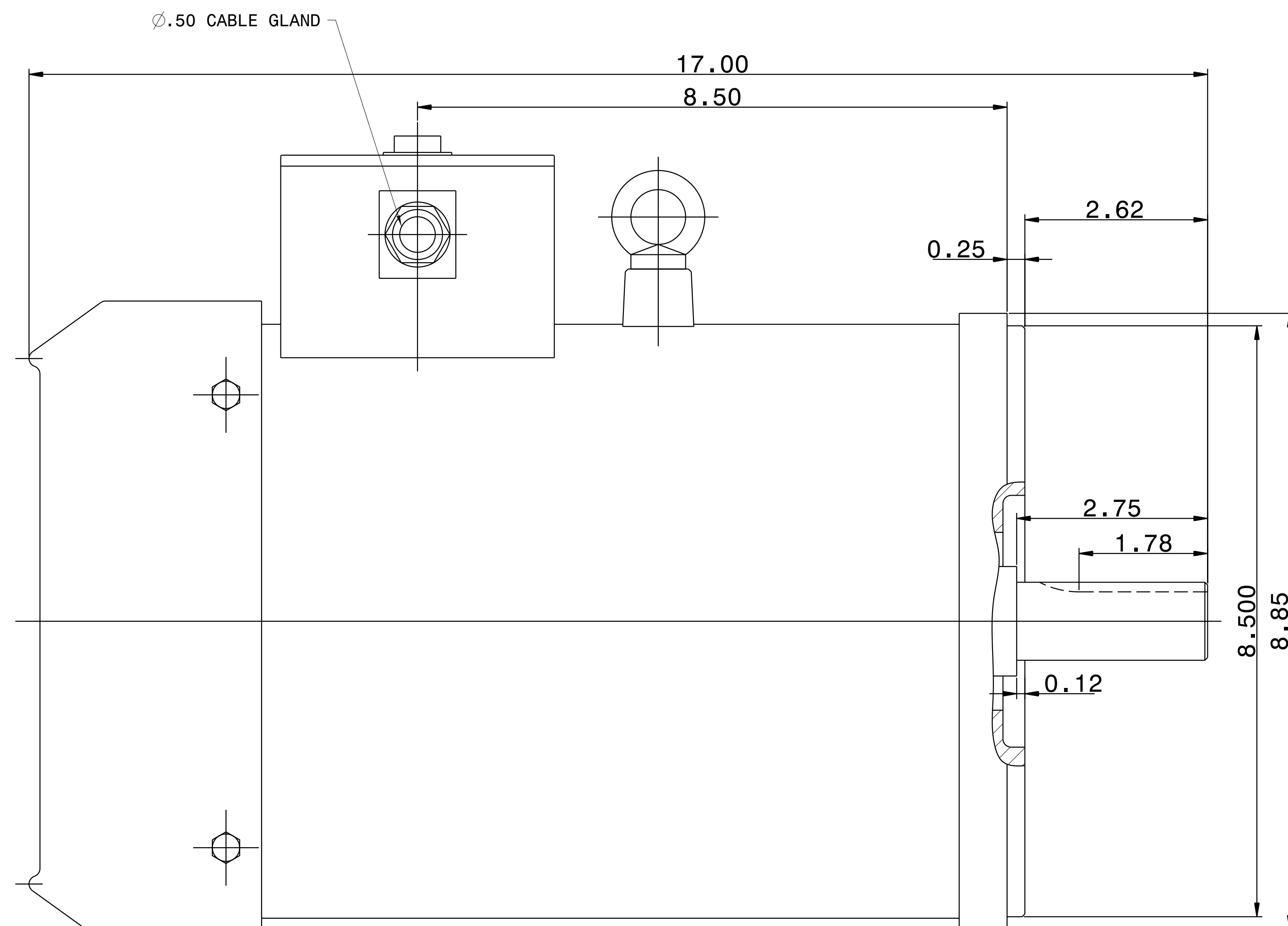

- NOTES: 1. DIMENSIONS IN INCH.  
 2. ENCLOSURE: IP56.  
 3. FOR DIRECT FLEXIBLE COUPLING.  
 4. STAINLESS STEEL CONSTRUCTION.

REF: 31049J806230	REV. DATA		
	TECO Westinghouse		REV NO 01
	3-PHASE INDUCTION MOTOR OUTLINE DIMENSIONS		DWG NO. WPV0034C
	DWN T. FELPS	020713	APPD S. GROHOSKY
TECO-WESTINGHOUSE MOTOR COMPANY		ROUND ROCK, TEXAS	USA