

DATE
DEC. 13, 2010
CAT. #: NP7/56

OUTLINE DIMENSIONS
3-PHASE INDUCTION MOTOR

MOTOR TYPE:
AEHH8P
FRAME NO. 254T

Pole	HP	kW	Hz	VOLT	Syn.Speed r/min(rpm)
6	7.5	5.6	50	190/380	1000

Ins	Rating	Dimension in	Approx Weight	Bearings
F	CONT.	inch	267 lbs.	DE: 6309ZZ NDE: 6307ZZ

Totally Enclosed Fan Cooled Squirrel Cage Rotor.

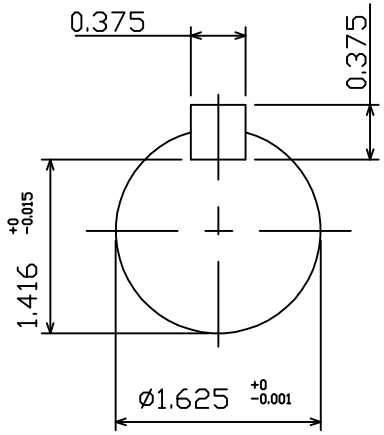
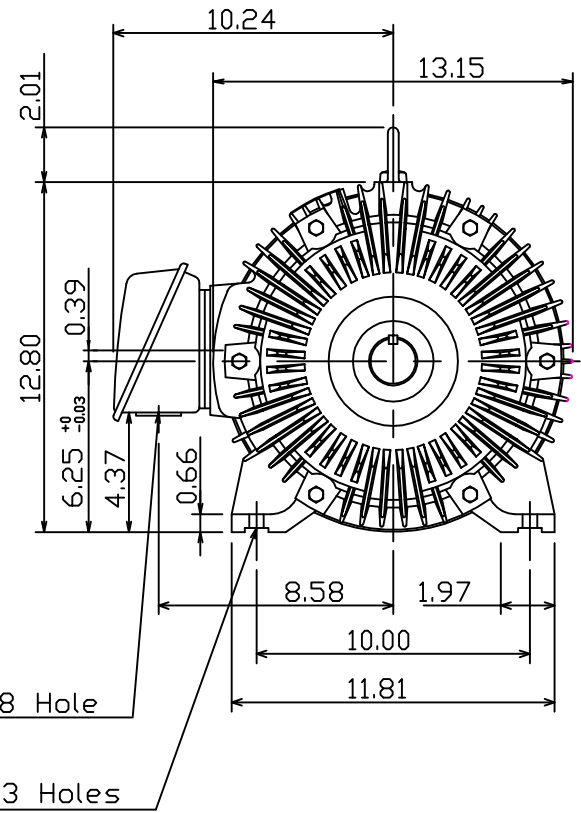
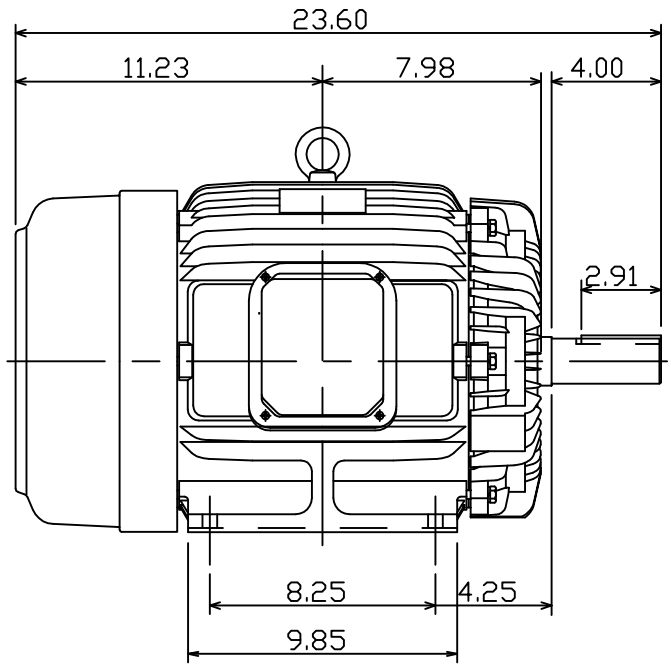

12.07.10 郭耿良

DWN, J.H.LIANG	05-20-99
CHKD, C.H.KAD	06-11-99
APPD, Y.B.HUANG	06-11-99



DWG NO.
31049J348202