

DATE
DEC. 16, 2010
CAT. #: NP0752

OUTLINE DIMENSIONS
3-PHASE INDUCTION MOTOR

MOTOR TYPE:
AEHH8P
FRAME NO. 365TS

Pole	HP	kW	Hz	VOLT	Syn.Speed r/min(rpm)
2	75	56	50	190/380	3000

Ins	Rating	Dimension in	Approx Weight	Bearings
F	CONT.	inches	791 lbs.	DE: 6312C3 NDE: 6212C3

Totally Enclosed Fan-Cooled Type. Squirrel-Cage Rotor.

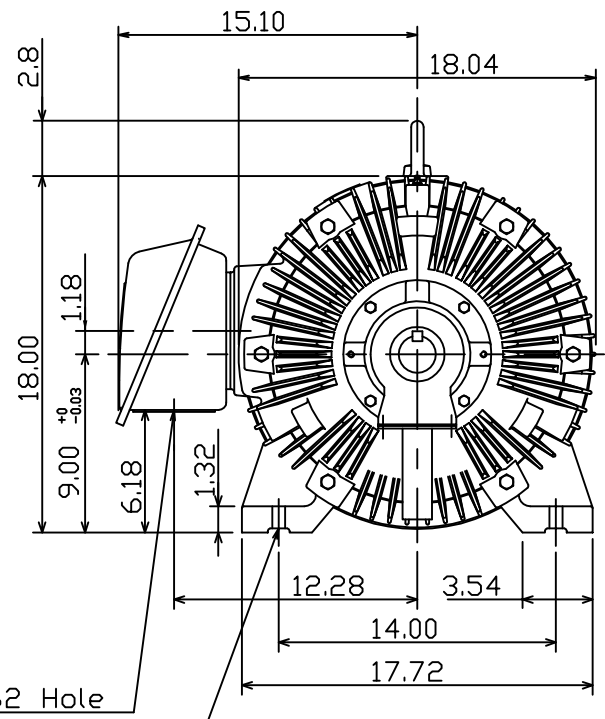
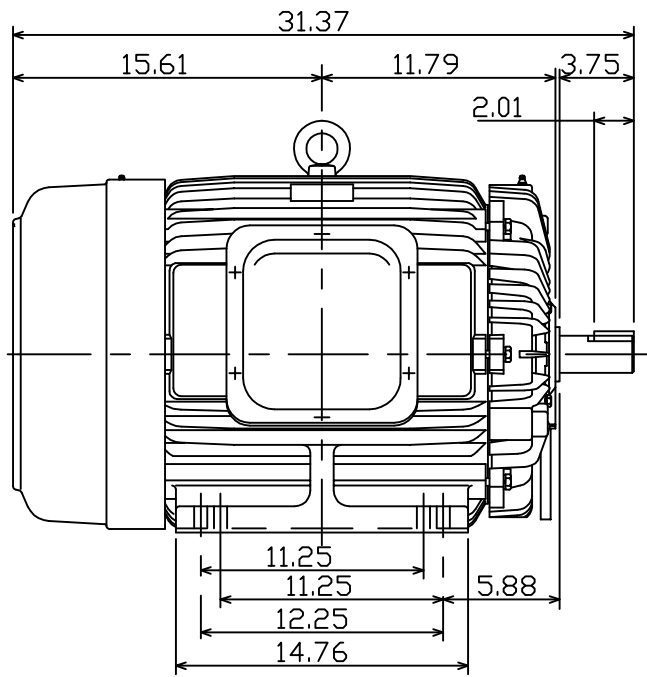

∅3.62 Hole

8-∅0.67 Holes

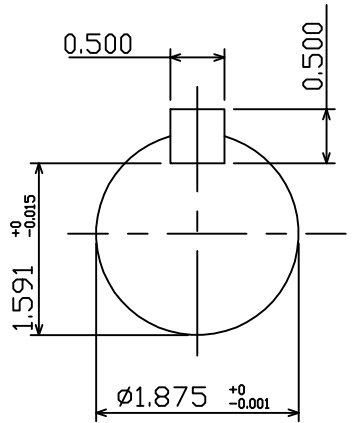

DWN.	K.L.KUD	12 06 10
CHKD.	K.L.KUD	12 07 10
APPD.	M.C.TSAI	12 07 10



DWG NO.
31049J360160