

DATE
JUNE 27, 2011

OUTLINE DIMENSIONS
3-PHASE INDUCTION MOTOR

MOTOR TYPE:
AEHH8P-CF
FRAME NO. 365TC

CAT. #: NP0506C

Pole	HP	kW	Hz	VOLT	Syn.Speed r/min(rpm)
6	50	37.3	60	230/460	1200

Ins	Rating	Dimension in	Approx Weight	Bearings
F	CONT.	inch	938 lbs.	DE: 6313 NDE: 6213

Totally Enclosed Fan-Cooled Type. Squirrel-Cage Rotor.

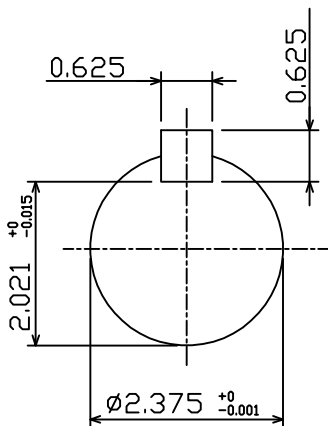
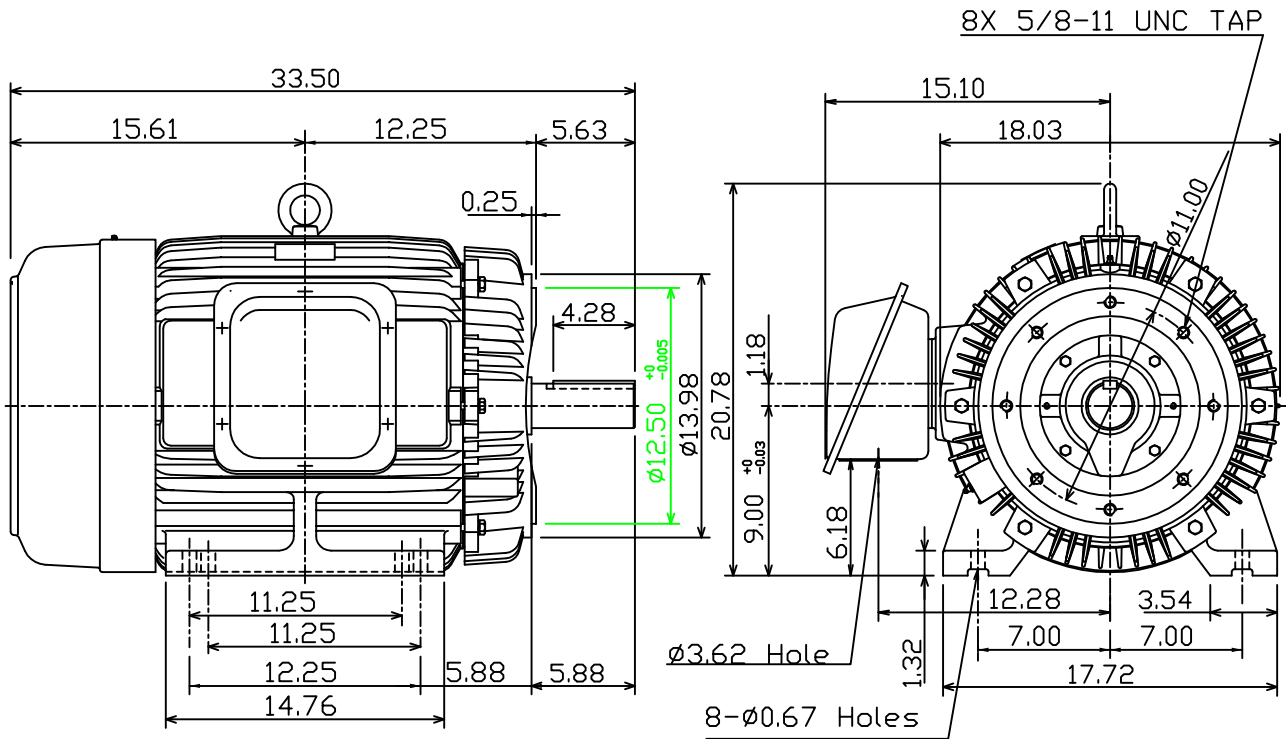

DWN.	K.L.KUD	04 -21 11
CHKD.	K.L.KUD	04 -21 11
APPD.	M.C.TSAI	04 -21 11



DWG NO.
31049J361540