

DATE
JAN. 15, 2015

CAT. #: NP0504G

OUTLINE DIMENSIONS

3-PHASE INDUCTION MOTOR

MOTOR TYPE:
AEHH8P-SGR

FRAME NO. 326T

Pole	HP	kW	Hz	VOLT	Syn.Speed r/min(rpm)
4	50	37.3	60	230/460	1800

Ins	Rating	Dimension in	Approx Weight	Bearings	
F	CONT.	inch	652 lbs.	DE: 6312	NDE: 6212

Totally Enclosed Fan-Cooled Type. Squirrel-cage Rotor.

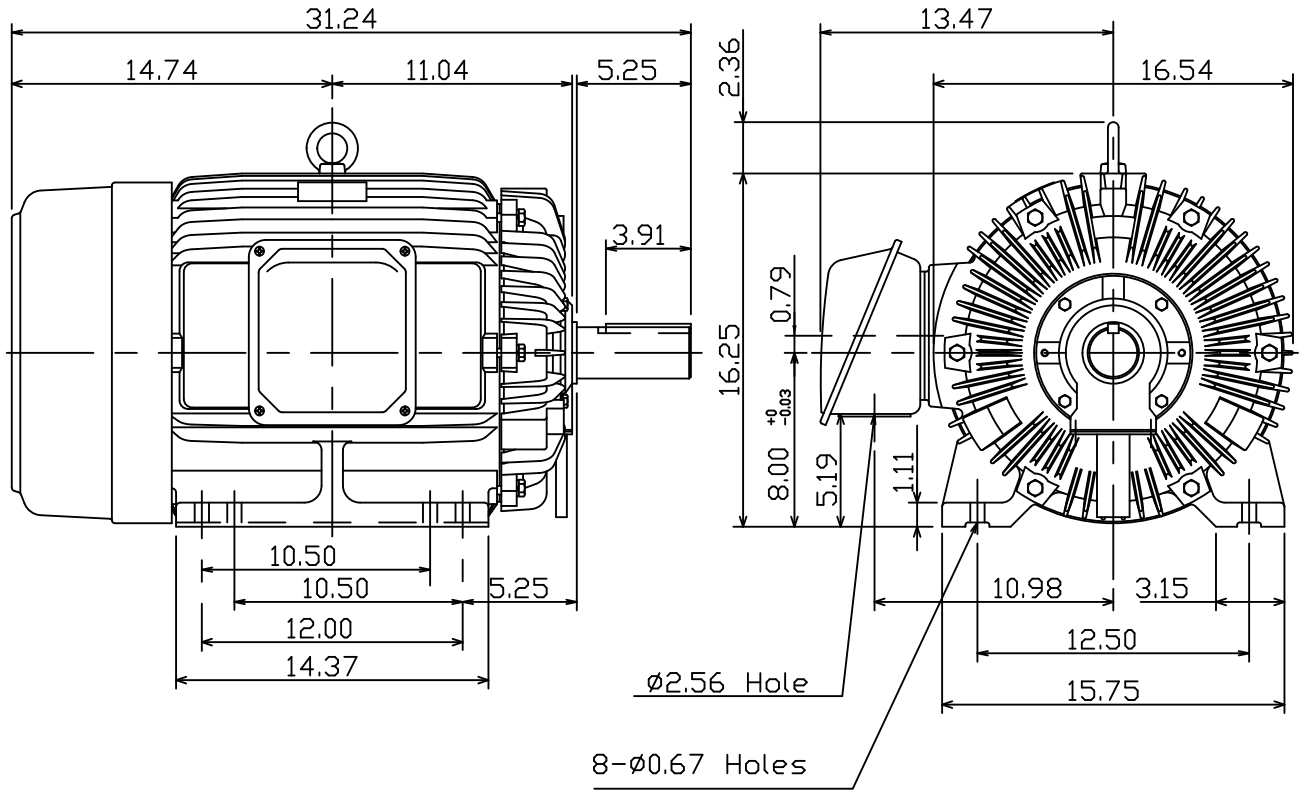

NOTE:
1. Shaft Grounding Ring installed-NDE



DWN.	K.L.KUD	12 06 10
CHKD.	K.L.KUD	12 07 10
APPD.	M.C.TSAI	12 07 10



DWG NO.
31049J357380