

DATE  
JULY 22, 2011

CAT. #: NP0404C

# OUTLINE DIMENSIONS

## 3-PHASE INDUCTION MOTOR

MOTOR TYPE:  
AEHH8P-CF

FRAME NO. 324TC

Pole	HP	kW	Hz	VOLT	Syn. Speed r/min(rpm)
4	40	29.8	60	230/460	1800

Ins	Rating	Dimension in	Approx Weight	Bearings	
F	CONT.	inches	656 lbs.	DE: 6312	NDE: 6212

Totally Enclosed Fan-Cooled Type. Squirrel-cage Rotor.

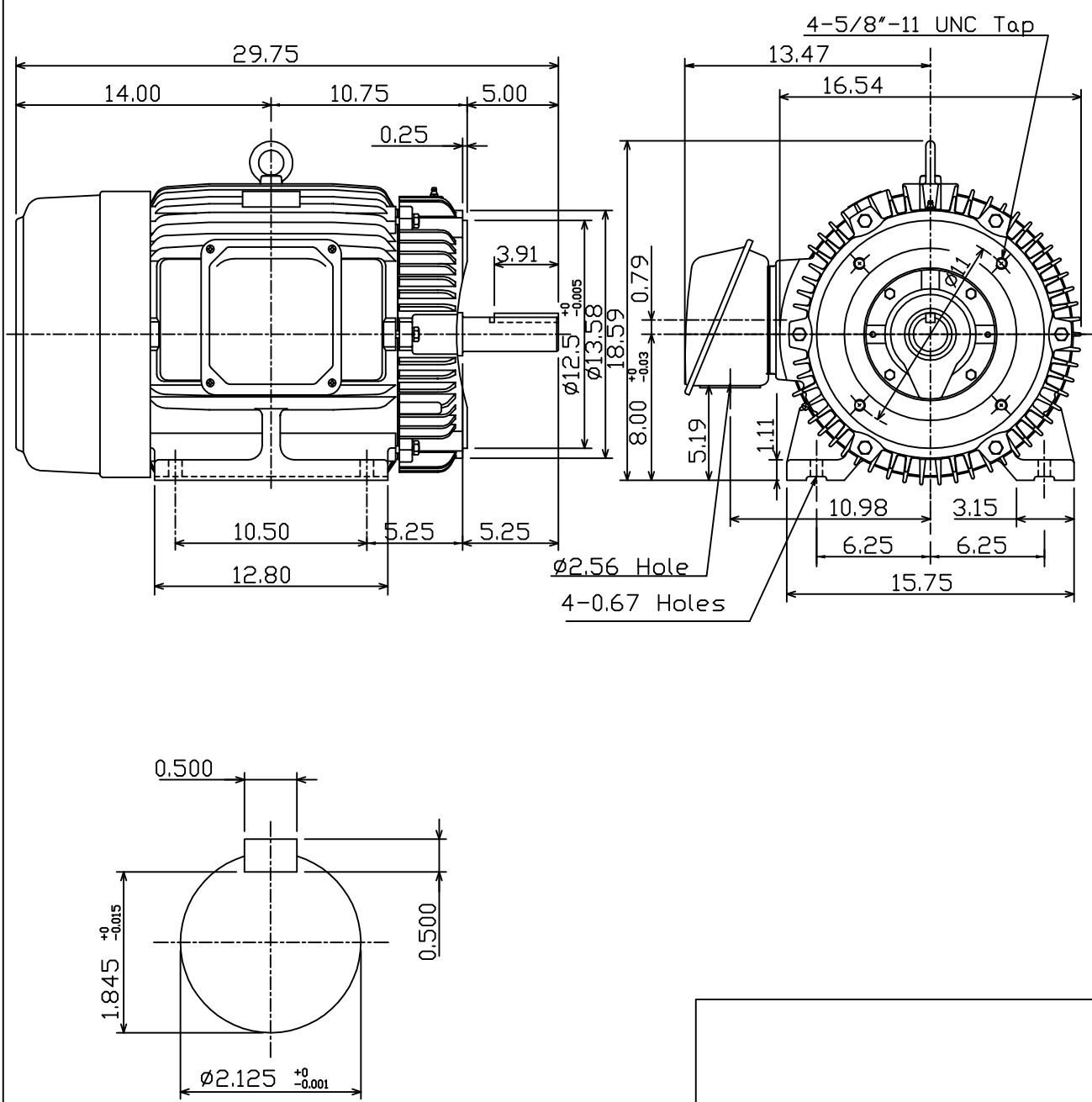

DWN.	K.L.KUD	04 -21 11
CHKD.	K.L.KUD	04 -21 11
APPD.	M.C.TSAI	04 -21 11



DWG NO.  
31049J355330