

DATE
JUNE 8, 2011
CAT. #: NP0304C

OUTLINE DIMENSIONS

3-PHASE INDUCTION MOTOR

MOTOR TYPE:
AEHH8P-CF
FRAME NO. 286TC

Pole	HP	kW	Hz	VOLT	Syn.Speed r/min(rpm)
4	30	22.4	60	230/460	1800

Ins	Rating	Dimension in	Approx Weight	Bearings
F	CONT.	inches	487 lbs.	DE: 6311ZZ NDE: 6310ZZ

Totally Enclosed Fan-Cooled Type.Squirrel-Cage Rotor.

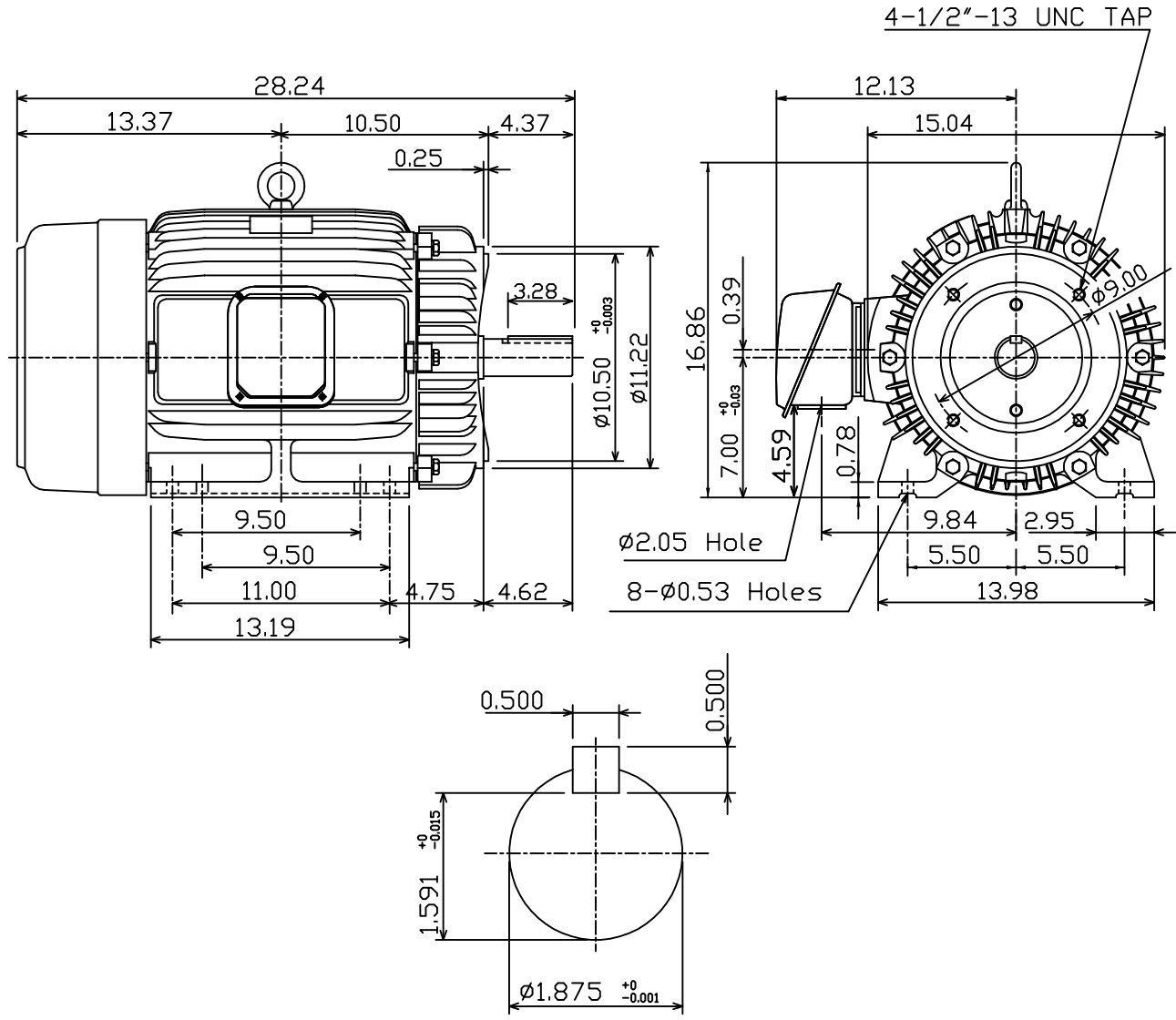

DWN,	K.L.KUD	04 -21 11
CHKD,	K.L.KUD	04 -21 11
APPD,	M.C.TSAI	04 -21 11



DWG NO.
31049J353310