

DATE DEC. 13, 2010	OUTLINE DIMENSIONS 3-PHASE INDUCTION MOTOR	MOTOR TYPE: AEHH8P
CAT. #: NP0254		FRAME NO. 284T

Pole	HP	kW	Hz	VOLT	Syn.Speed r/min(rpm)
4	25	18.7	50	190/380	1500

Ins	Rating	Dimension in	Approx Weight	Bearings	
F	CONT.	inches	399 lbs.	DE: 6311ZZ	NDE: 6310ZZ

Totally Enclosed Fan-Cooled Type.Squirrel-Cage Rotor.

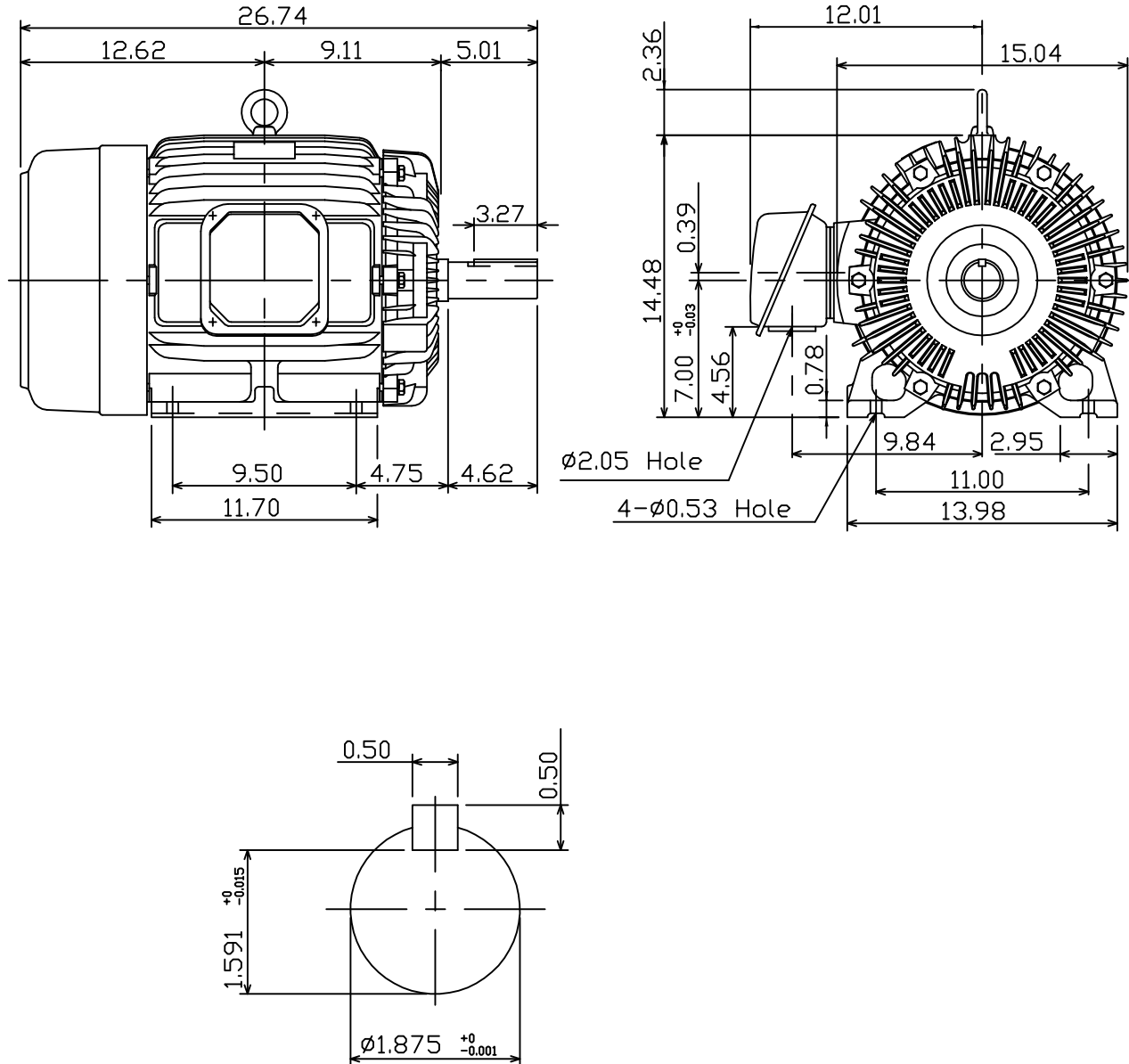

12.06.10	郭耿良
----------	-----

DWN, J.H.LIANG	06-25-98	TECO Westinghouse	DWG NO.
CHKD, C.H.KAO	06-29-98		31057H206002
APPD, Y.B.HUANG	06-29-98		