

DATE
DEC. 13, 2010
CAT. #: NP0206

OUTLINE DIMENSIONS
3-PHASE INDUCTION MOTOR

MOTOR TYPE:
AEHH8P
FRAME NO. 286T

Pole	HP	kW	Hz	VOLT	Syn.Speed r/min(rpm)
6	20	14.9	60	230/460	1200

Ins	Rating	Dimension in	Approx Weight	Bearings
F	CONT.	inch	454 lbs.	DE: 6311ZZ NDE: 6310ZZ

Totally Enclosed Fan Cooled Type, Squirrel-cage Rotor.

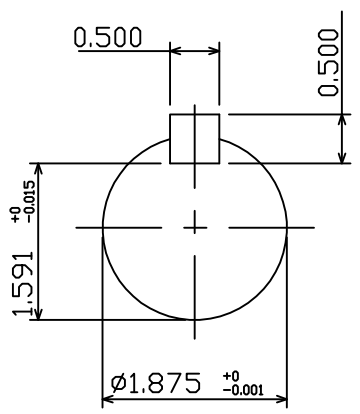
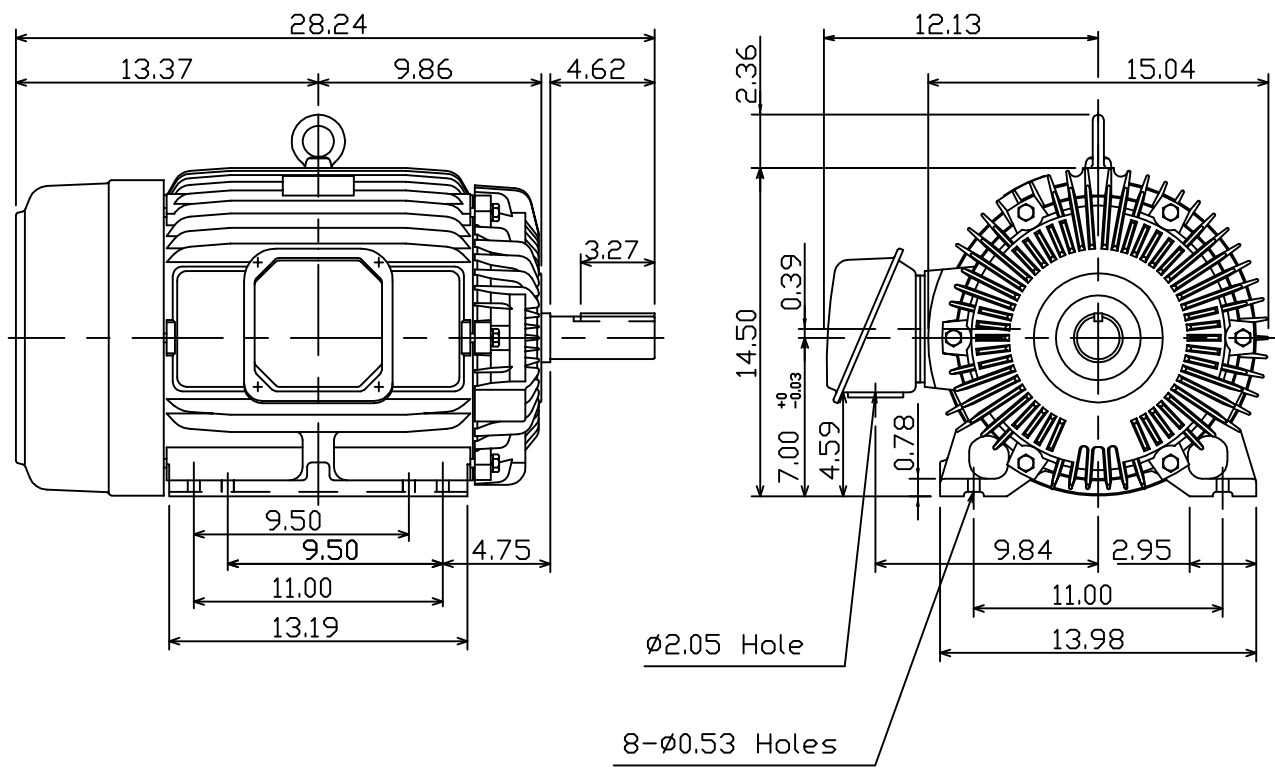

DWN.	K.L.KUD	12 06 10
CHKD.	K.L.KUD	12 07 10
APPD.	M.C.TSAI	12 07 10



DWG NO.
31049J353300