

DATE
DEC. 13, 2010

OUTLINE DIMENSIONS

3-PHASE INDUCTION MOTOR

MOTOR TYPE:
AEHH8P
FRAME NO. 256T

CAT. #: NP0204

Pole	HP	kW	Hz	VOLT	Syn.Speed r/min(rpm)
4	20	14.9	50	190/380	1500

Ins	Rating	Dimension in	Approx Weight	Bearings
F	CONT.	inch	311 lbs.	DE: 6309ZZ NDE: 6307ZZ

Totally Enclosed Fan Cooled Squirrel Cage Rotor.

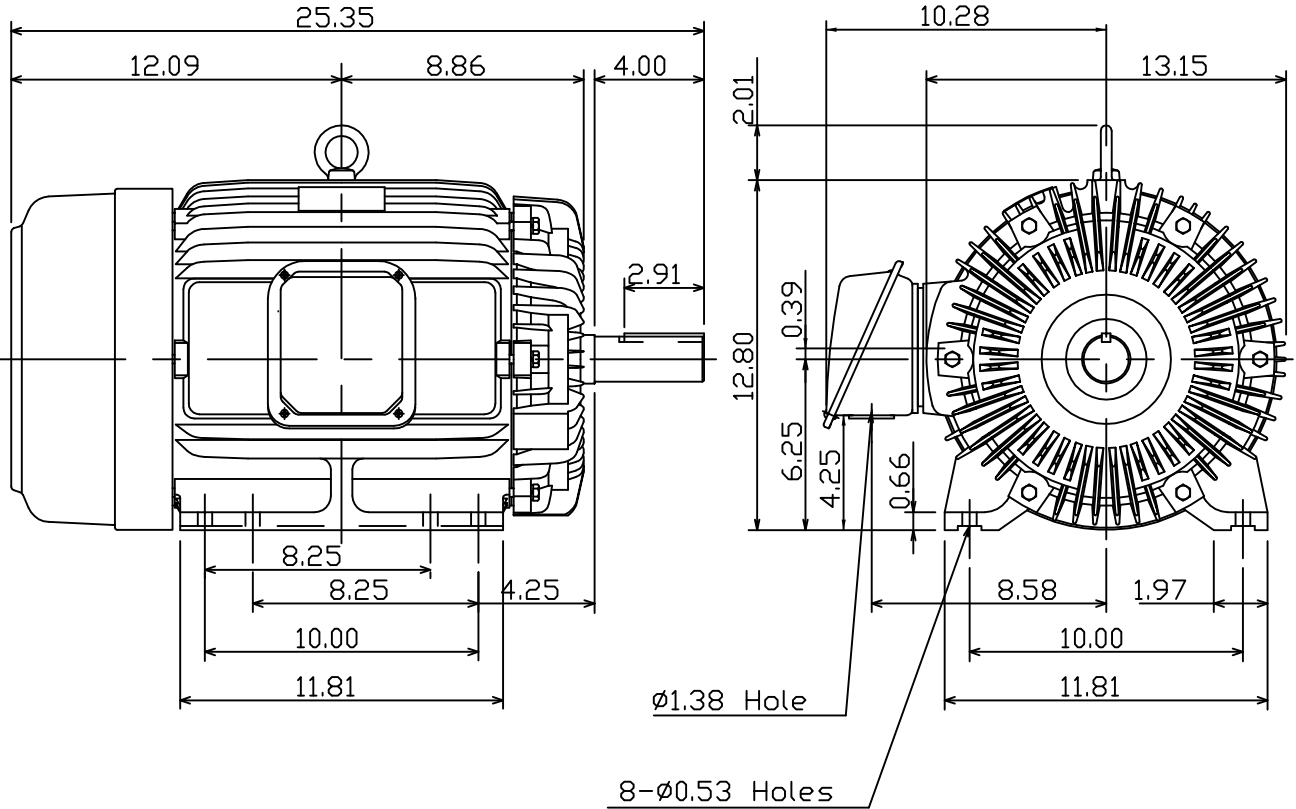

DWN.	K.L.KUD	12 07 10
CHKD.	K.L.KUD	12 07 10
APPD.	M.C.TSAI	12 07 10

TECO Westinghouse

DWG NO.
31049J349210