

DATE
DEC. 13, 2010
CAT. #: NP0156

OUTLINE DIMENSIONS

3-PHASE INDUCTION MOTOR

MOTOR TYPE:
AEHH8P
FRAME NO. 284T

Pole	HP	kW	Hz	VOLT	Syn.Speed r/min(rpm)
6	15	11.2	50	190/380	1000

Ins	Rating	Dimension in	Approx Weight	Bearings
F	CONT.	inches	399 lbs.	DE: 6311ZZ NDE: 6310ZZ

Totally Enclosed Fan-Cooled Type.Squirrel-Cage Rotor.

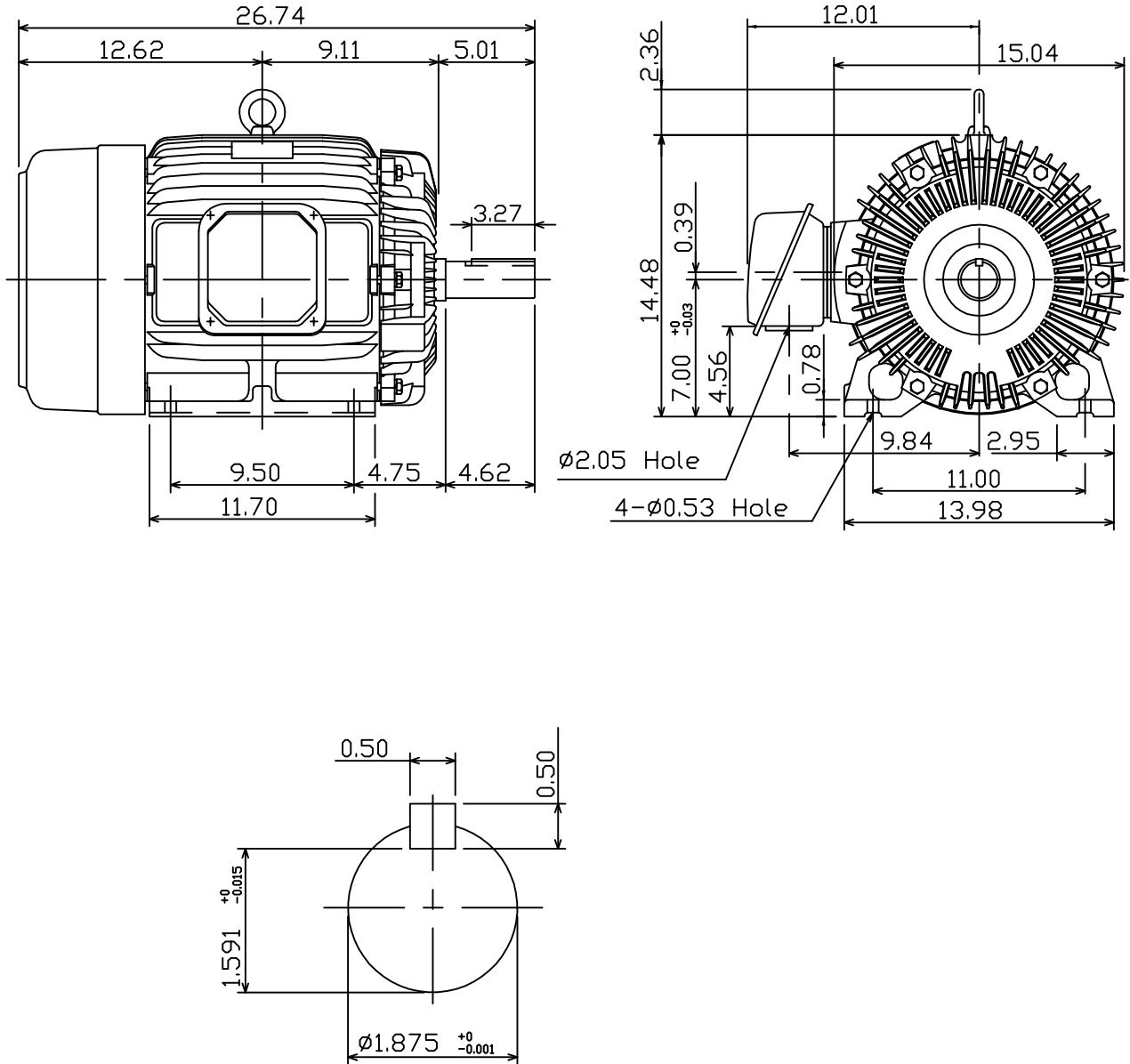

12.06.10 郭耿良

DWN, J.H.LIANG 06-25-98
CHKD, C.H.KAO 06-29-98
APPD, Y.B.HUANG 06-29-98



DWG NO.
31057H206002