

DATE  
APRIL 25, 2011  
CAT. #: NP0152C

OUTLINE DIMENSIONS  
3-PHASE INDUCTION MOTOR

MOTOR TYPE:  
AEHH8P-CF  
FRAME NO. 254TC

Pole	HP	kW	Hz	VOLT	Syn.Speed r/min(rpm)
2	15	11.2	60	230/460	3600

Ins	Rating	Dimension in	Approx Weight	Bearings
F	CONT.	inch	287 lbs.	DE: 6309ZZ NDE: 6307ZZ

Totally Enclosed Fan Cooled Squirrel Cage Rotor.

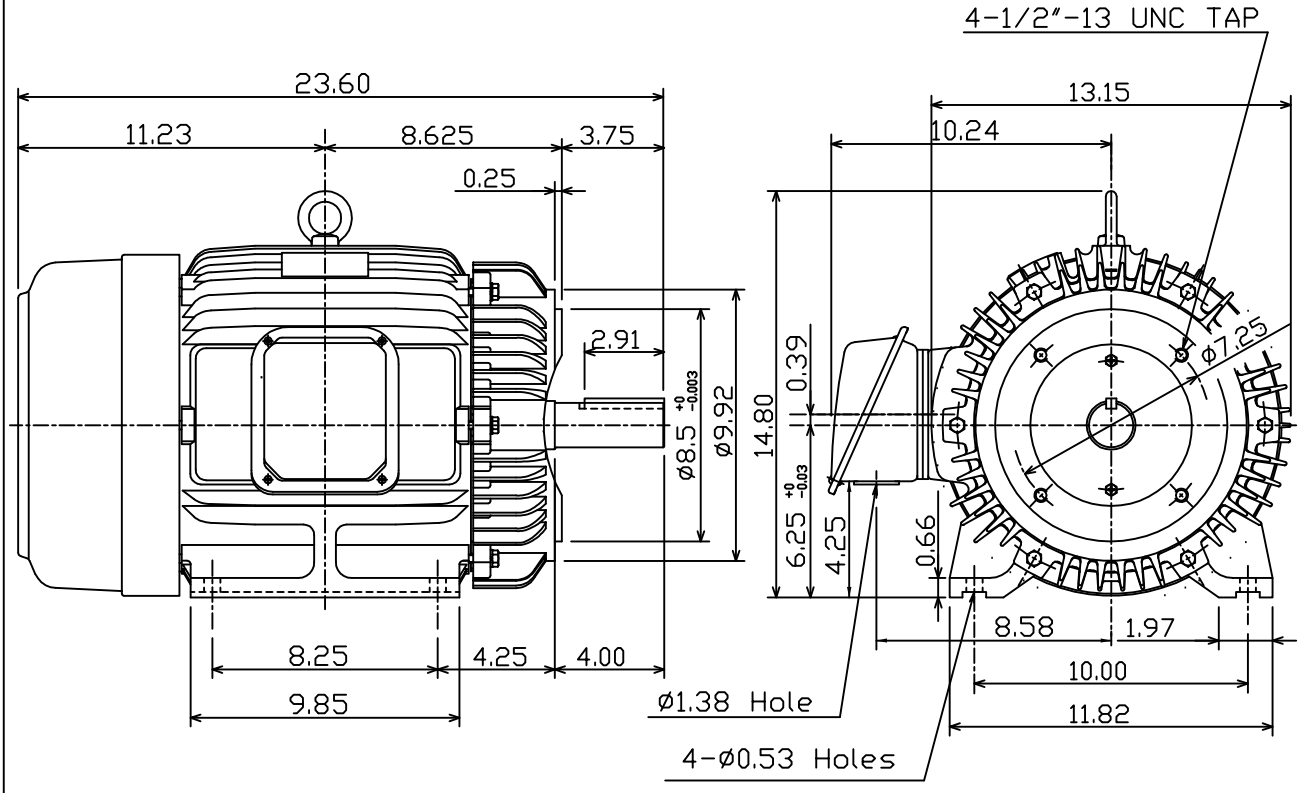

12.11.02      油嘴取消      K.L.KUO

DWN.	J.C.LIN	09-01-00
CHKD.	C.H.KAD	12-30-00
APPD.	Y.B.HUANG	12-30-00



DWG NO.  
31049J348251