

DATE
APRIL 26, 2011

OUTLINE DIMENSIONS
3-PHASE INDUCTION MOTOR

MOTOR TYPE:
AEHH8P-CF
FRAME NO. 256TC

CAT. #: NP0106C

Pole	HP	kW	Hz	VOLT	Syn.Speed r/min(rpm)
6	10	7.5	60	230/460	1200

Ins	Rating	Dimension in	Approx Weight	Bearings
F	CONT.	inch	334 lbs.	DE: 6309ZZ NDE: 6307ZZ

Totally Enclosed Fan Cooled Squirrel Cage Rotor.

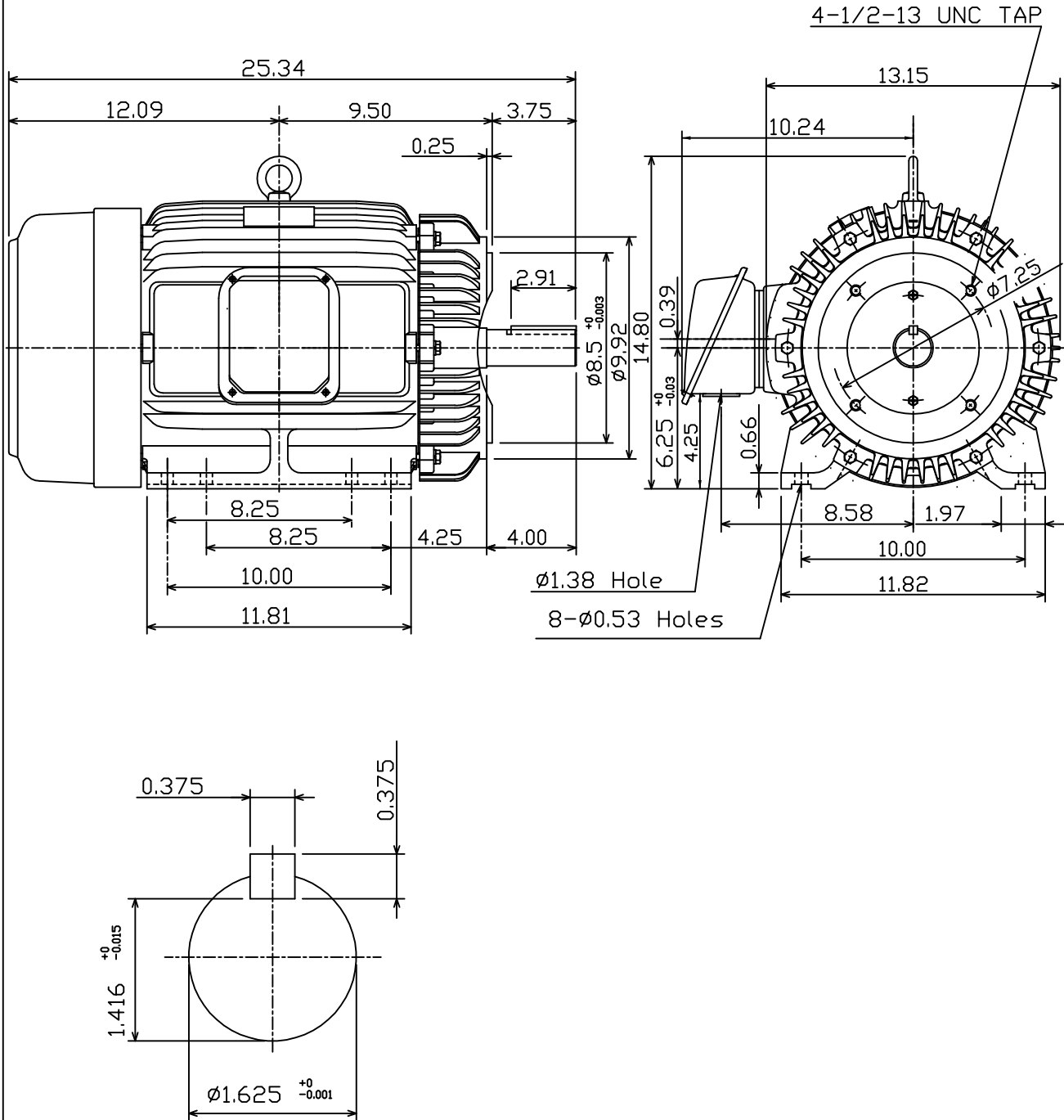

DWN, J.H.LIANG	04-23-11
CHKD, J.H.LIANG	04-23-11
APPD, M.C.TSAI	04-23-11



DWG NO.
31049J349220