

DATE
APRIL 26, 2011
CAT. #: NP0054C

OUTLINE DIMENSIONS
3-PHASE INDUCTION MOTOR

MOTOR TYPE:
AEHH8P-CF
FRAME NO. 184TC

Pole	HP	kW	Hz	VOLT	Syn.Speed r/min(rpm)
4	5	3.73	60	230/460	1800

Ins	Rating	Dimension in	Approx Weight	Bearings
F	CONT.	inches	102 lbs.	DE: 6306ZZ NDE: 6306ZZ

Totally Enclosed Fan-Cooled Type. Squirrel-Cage Rotor.

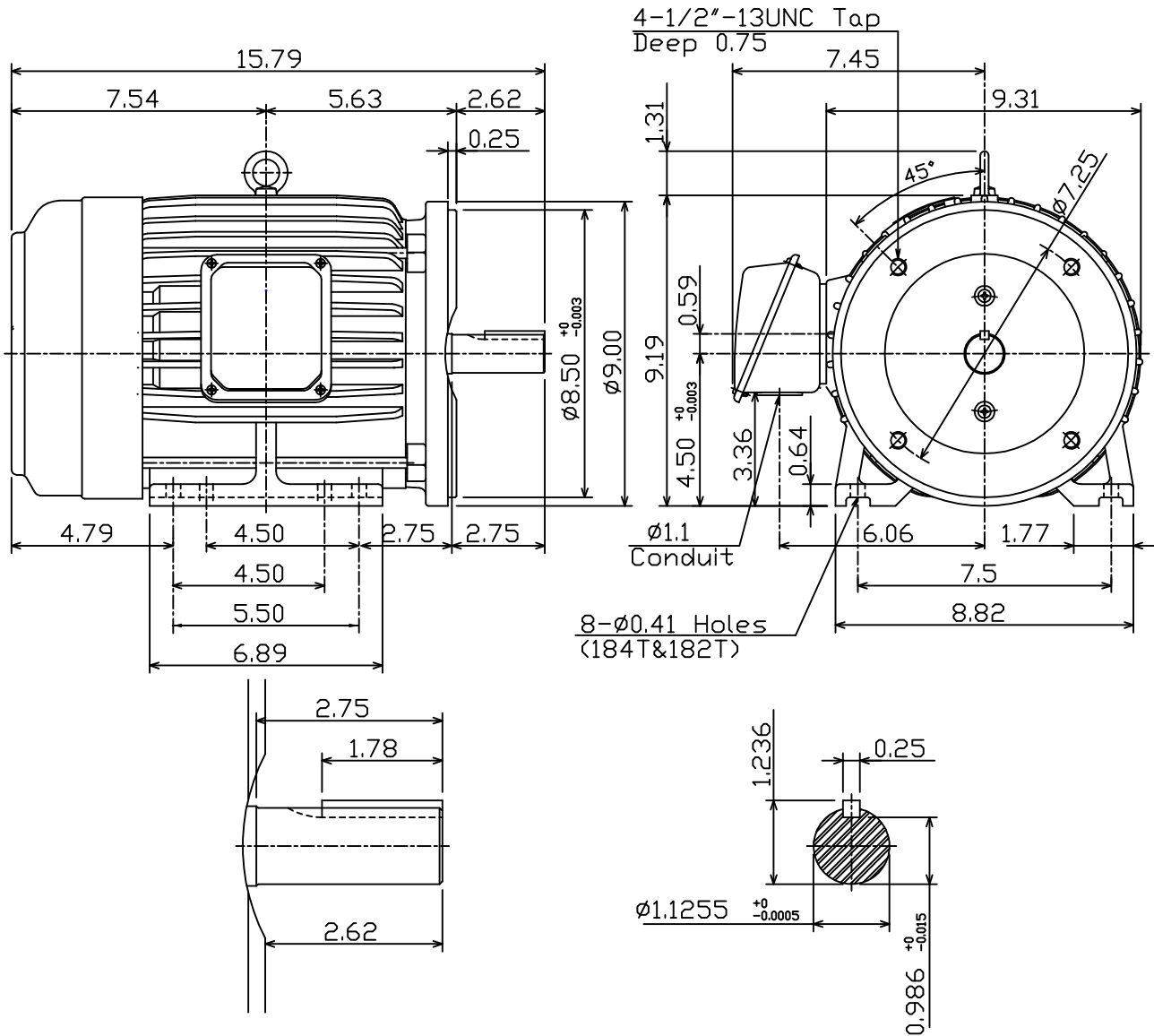

DWN.	C.S.LD	12-21-04
CHKD.	C.S.LD	12-27-04
APPD.	M.C.TSAI	12-27-04



DWG NO.
31049D190960