

DATE
JAN. 15, 2015
CAT. #: NP0026G

OUTLINE DIMENSIONS

3-PHASE INDUCTION MOTOR

MOTOR TYPE:
AEHH8P-SGR
FRAME NO. 184T

Pole	HP	kW	Hz	VOLT	Syn. Speed r/min(rpm)
6	2	1.49	60	230/460	1200

Ins	Rating	Dimension in	Approx Weight	Bearings
F	CONT.	inch	95 lbs.	DE: 6306ZZ NDE: 6306ZZ

Totally Enclosed Fan Cooled Squirrel Cage Rotor.

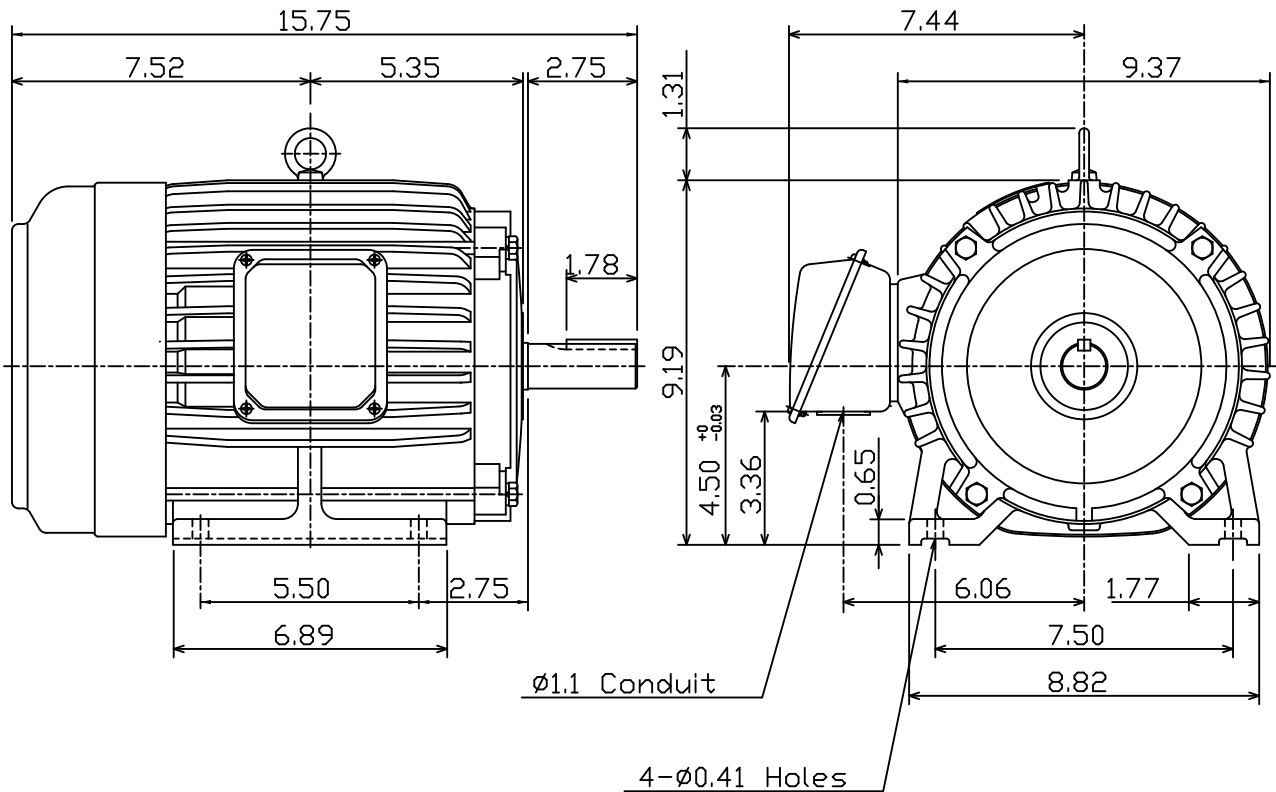

NOTE:
1. Shaft Grounding Ring installed-NDE

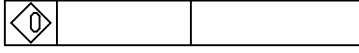

DWN.	J.H.LIANG	05-20-99
CHKD.	C.S.LO	05-26-99
APPD.	Y.B.HUANG	05-26-99



DWG NO.
31049D190560