

DATE
Sept. 12, 2005
CAT. #: HH0504

OUTLINE DIMENSIONS
3-PHASE INDUCTION MOTOR

MOTOR TYPE:
AEHH
FRAME NO. 326T

Pole	HP	kW	Hz	VOLT	Syn. Speed r/min(rpm)
4	50	37.3	60	460	1800

Ins	Rating	Dimension in	Approx Weight	Bearings
F	CONT.	inch	675 lbs.	DE: 6312ZC3 NDE: 6212ZC3

Totally Enclosed Fan-Cooled Type. Squirrel-Cage Rotor.

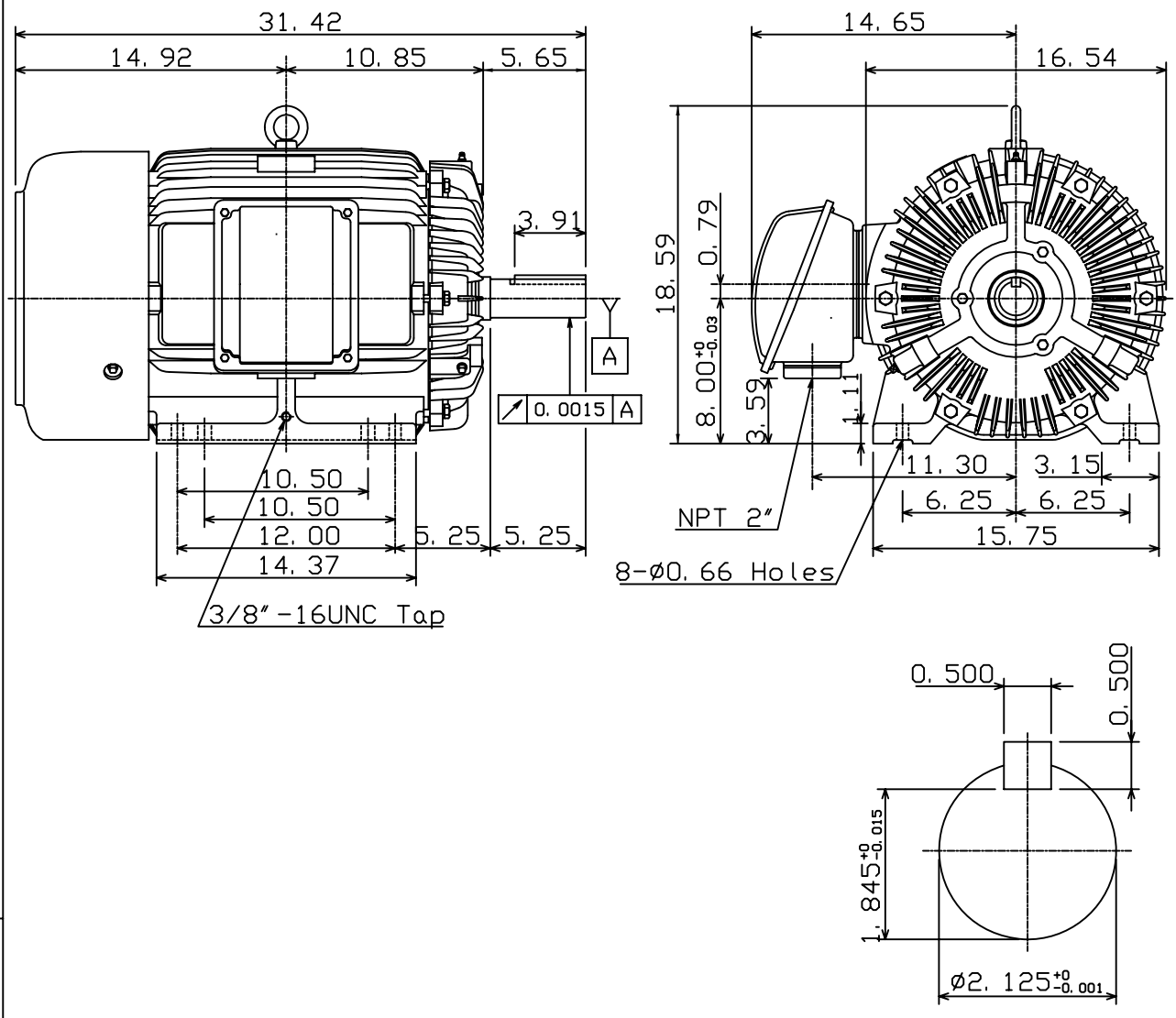

◇		
---	--	--

DWN.	K. L. KUO	01-15-05
CHKD.	C. H. KAO	02-02-05
APPD.	M. C. TSAI	02-02-05



DWG NO.
31049M630120