

DATE
APRIL 27, 2003
CATALOG NO.
HH0154-50

OUTLINE DIMENSIONS
3-PHASE INDUCTION MOTOR

MOTOR TYPE:
AEHH
FRAME NO. 254T

Pole	HP	KW	Hz	VOLT	Syn.Speed RPM
4	15	11	50	380	1500

Ins	Rating	Dimension in	Approx Weight	Bearings
F	CONT.	inches	297 lbs.	DE: 6309ZC35C NDE: 6307ZC35C

Totally Enclosed Fan-Cooled Type. Squirrel-cage Rotor.

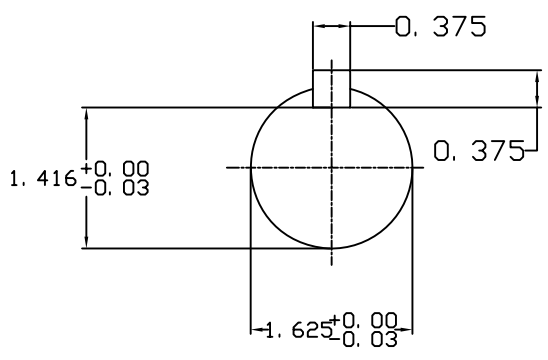
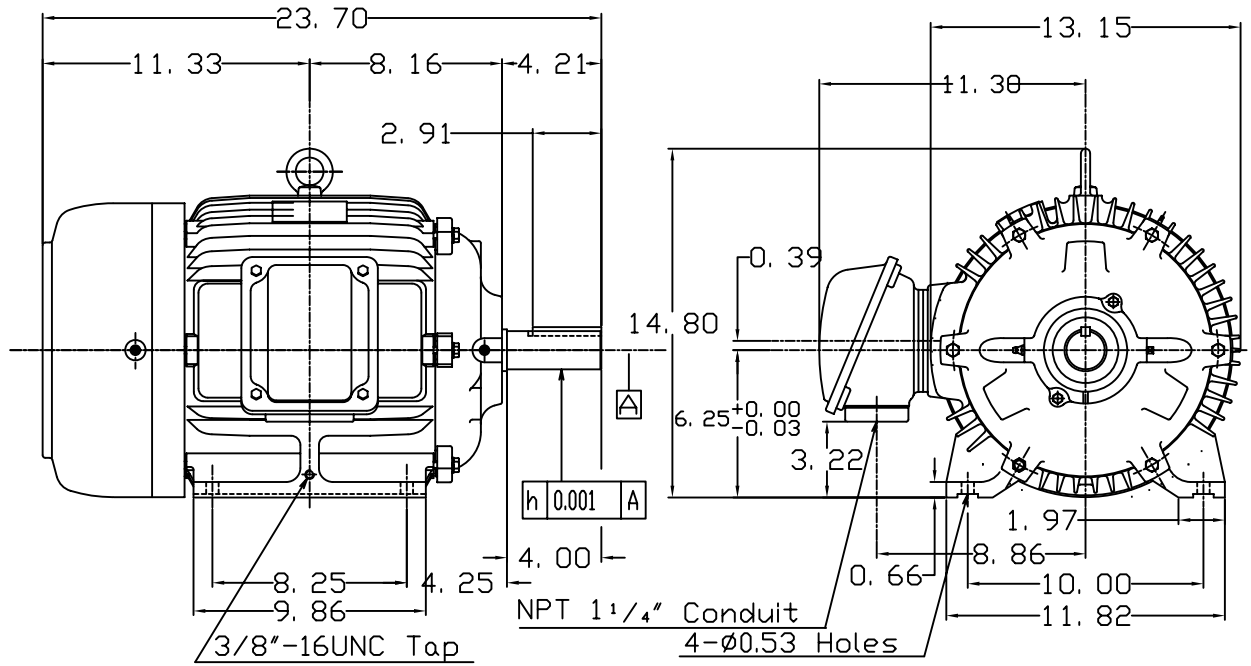

DWN.	簡學民	12-04-98
CHKD.	高金星	12-10-98
APPD.	黃友伯	12-10-98



DWG NO.
31049M625060