

DATE
January 21, 2009
CAT. #:

OUTLINE DIMENSIONS
3-PHASE INDUCTION MOTOR

MOTOR TYPE:
AEUH8B-DC
FRAME NO. 215TC

Pole	HP	kW	Hz	VOLT	Syn.Speed r/min(rpm)
2/4/6/8	-	-	60	460	-

Ins	Rating	Dimension in	Approx Weight	Bearings
F	CONT.	inches	203 LBS	DE: 6308ZC3 NDE: 6306ZC3

Totally Enclosed Fan-Cooled Vertical Type. Squirrel-Cage Rotor.

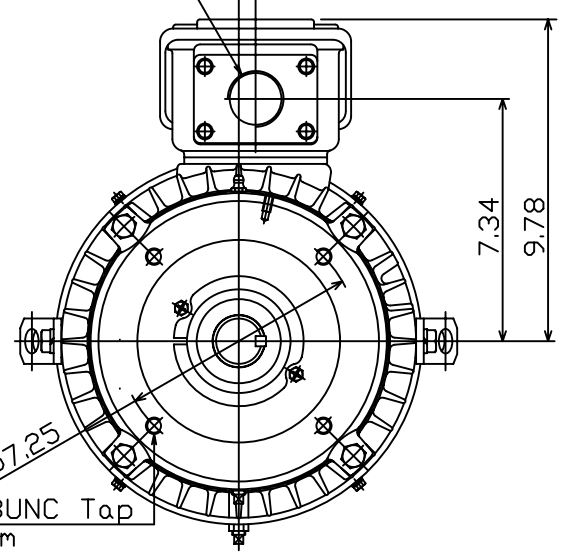
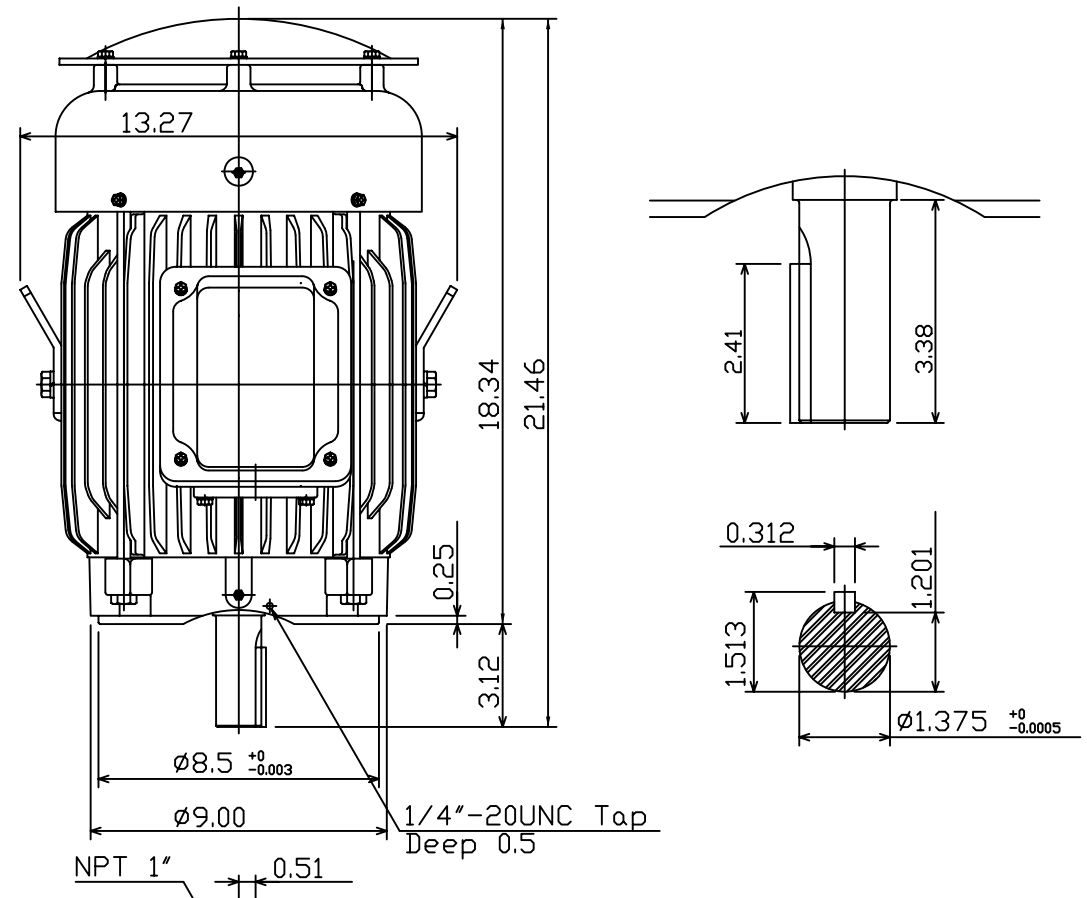

Note:
1. With Inpro Seals
On Both End.

◇		
---	--	--

DWN.	???????	01 07 09
CHKD.	???????	01 14 09
APPD.	???????	01 14 09



DWG NO.
31049M987170