

TYPE	OUTPUT		POLE	TIME RATING	VOLTAGE V	Hz	SYN. SPEED R.P.M
	HP.	kW.					
AEHH8B	125	93.3	8	CONT.	460	60	900

TOTALLY ENCLOSED FAN-COOLED TYPE. SQUIRREL-CAGE ROTOR

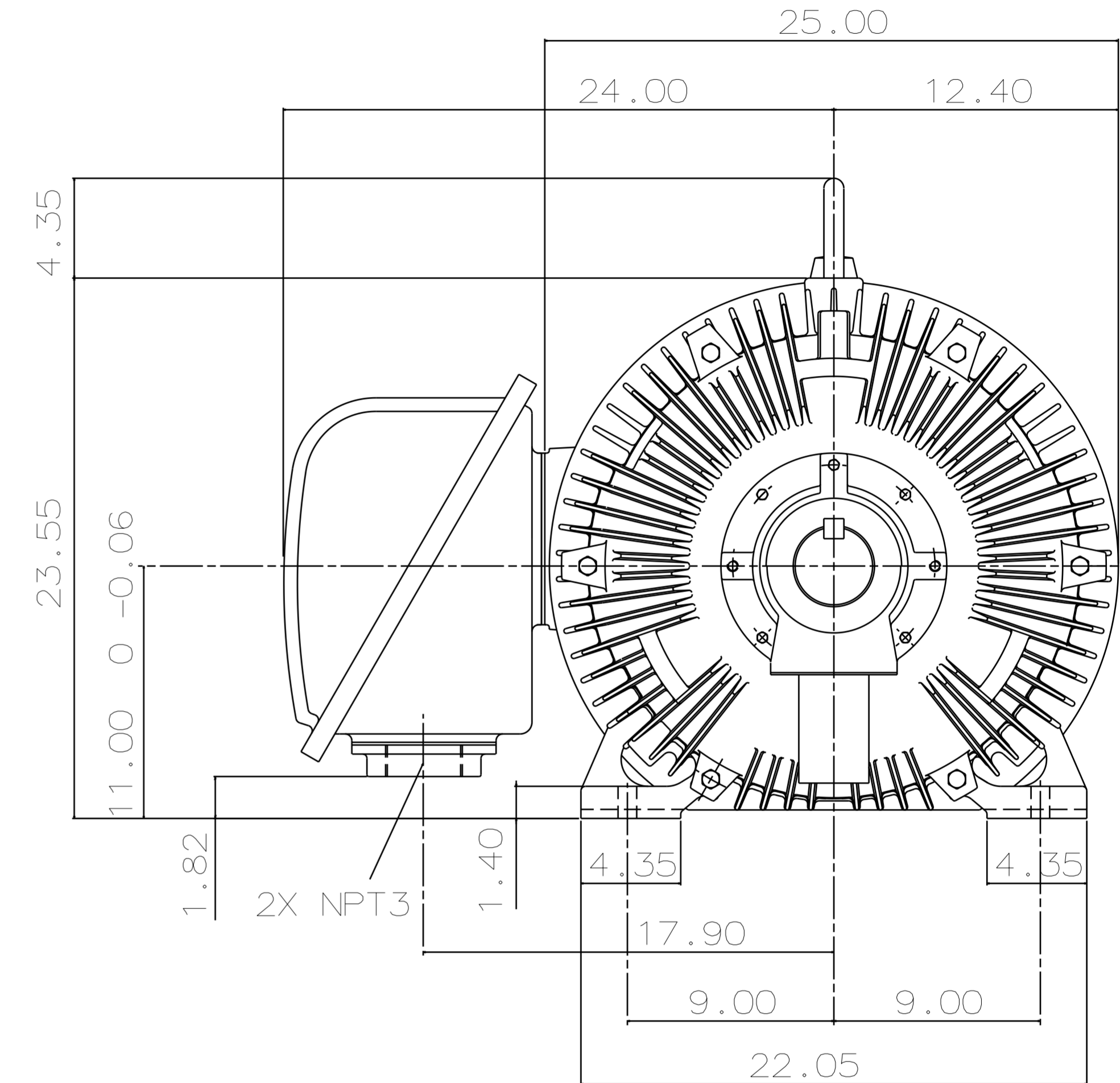
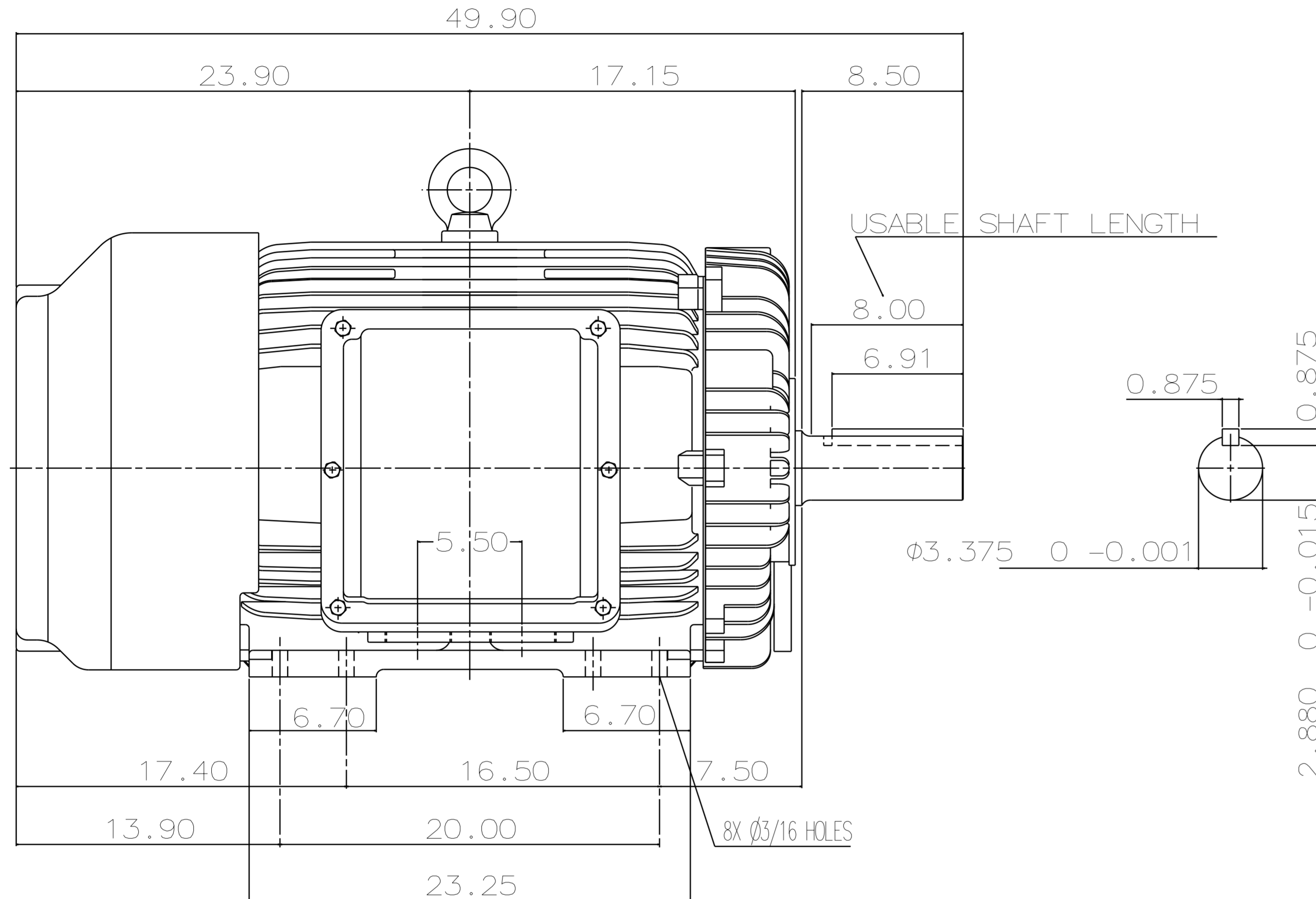

NOTE :

1. DIMENSIONS IN INCH
2. FRAME NO. 447T
3. F CLASS INSULATION, S.F.1.15
4. FOR DIRECT FLEXIBLE COUPLING
5. ENCLOSURE: IP55
6. BEARING SIZE: DRIVE END: 6320C3
NON-DRIVE END: 6316C3
7. APPROX. WEIGHT: 2500 LBS
8. INPRO SEAL ON BOTH ENDS.
9. NON-SPARKING FAN.
10. NOISE BELOW 83 DBA AT 1 METER AT NO LOAD.
11. VIBRATION VERTICAL/HORIZONTAL BELOW 0.08 IN/SEC
AXIAL BELOW 0.06 IN/SEC.

TW-56BC

DATE	12-12-17	OUTLINE DIMENSIONS
CATALOG #	#HB1258	3-PHASE INDUCTION MOTOR
TECO Westinghouse		DWG NO. REV: 02
		3A040Y700

DWN.	T.H.Pan	FEB •18 •2005
CHKD.	H.HUANG	FEB •18 •2005
APPD.	C.WANG	FEB •18 •2005