

DATE
Sept. 13, 2005
CAT. #: HB0756-50

OUTLINE DIMENSIONS
3-PHASE INDUCTION MOTOR

MOTOR TYPE:
AEHH8B
FRAME NO. 405T

Pole	HP	kW	Hz	VOLT	Syn. Speed r/min(rpm)
6	75	56	50	380	1000

Ins	Rating	Dimension in	Approx Weight	Bearings
F	CONT.	inches	1220 lbs.	DE: 6317C3 NDE: 6313ZC35C

Totally Enclosed Fan-Cooled Type, Squirrel-cage Rotor.

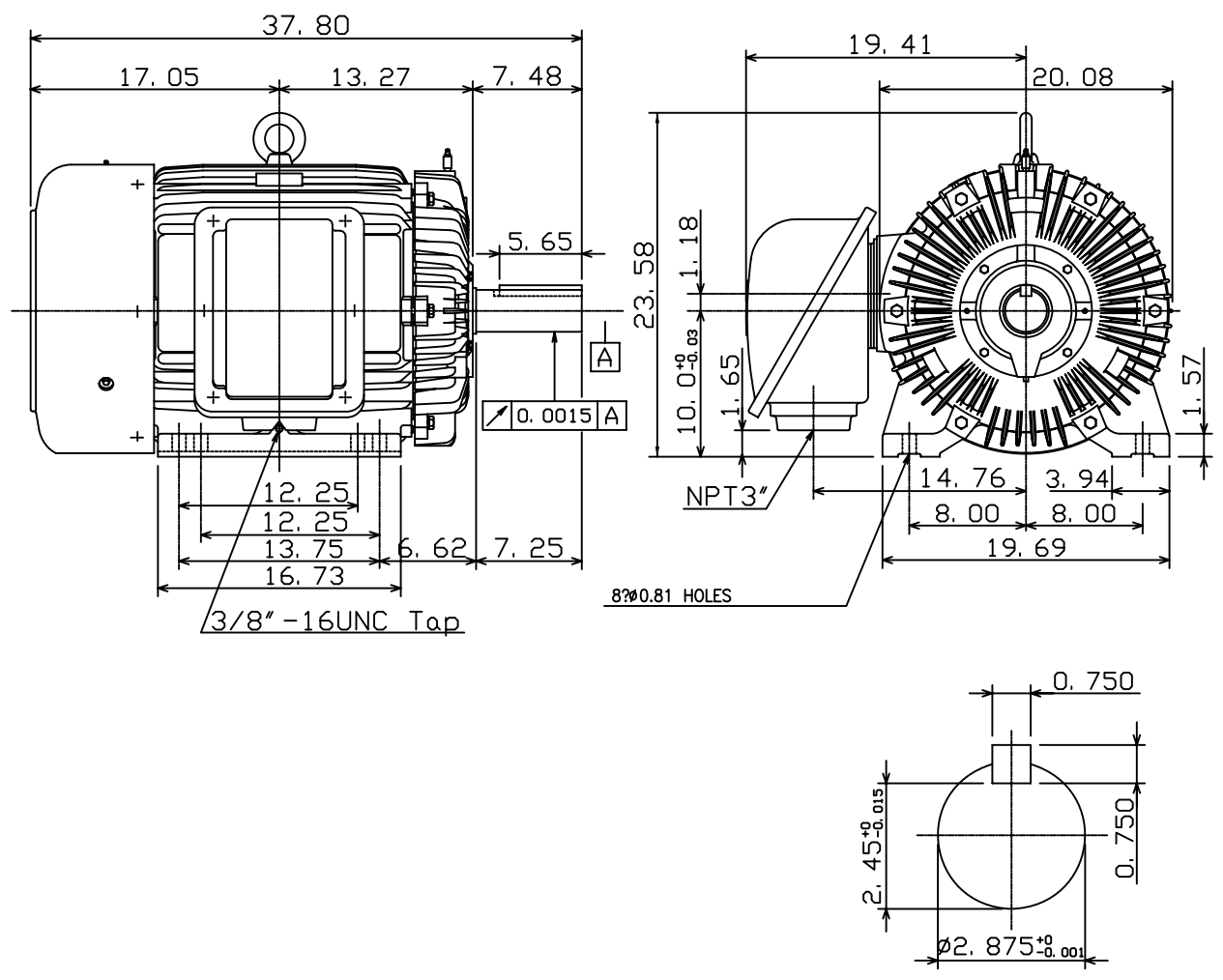

- Note:
1. Motor Vibration: 20μ.
 2. Inpro/Seal in Both End Brackets

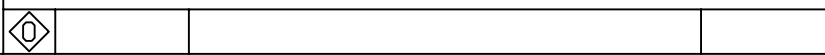

DWN.	K. L. KUO	01-20-05
CHKD.	C. H. KAO	02-02-05
APPD.	M. C. TSAI	02-02-05



DWG NO.
31049M634640