

DATE
Sept. 13, 2005
CAT. #: HBO104

OUTLINE DIMENSIONS

3-PHASE INDUCTION MOTOR

MOTOR TYPE:
AEHH8B
FRAME NO. 215T

Pole	HP	kW	Hz	VOLT	Syn. Speed r/min(rpm)
4	10	7.5	60	460	1800

Ins	Rating	Dimension in	Approx Weight	Bearings
F	CONT.	inches	194 lbs	DE: 6308ZC35C NDE: 6306ZC35C

Totally Enclosed Fan-Cooled Type, Squirrel-Cage Rotor.

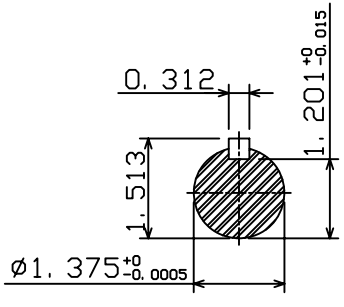
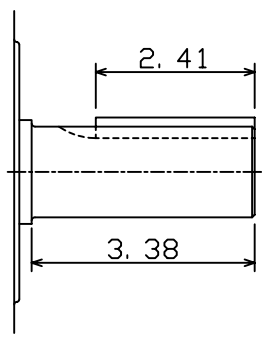
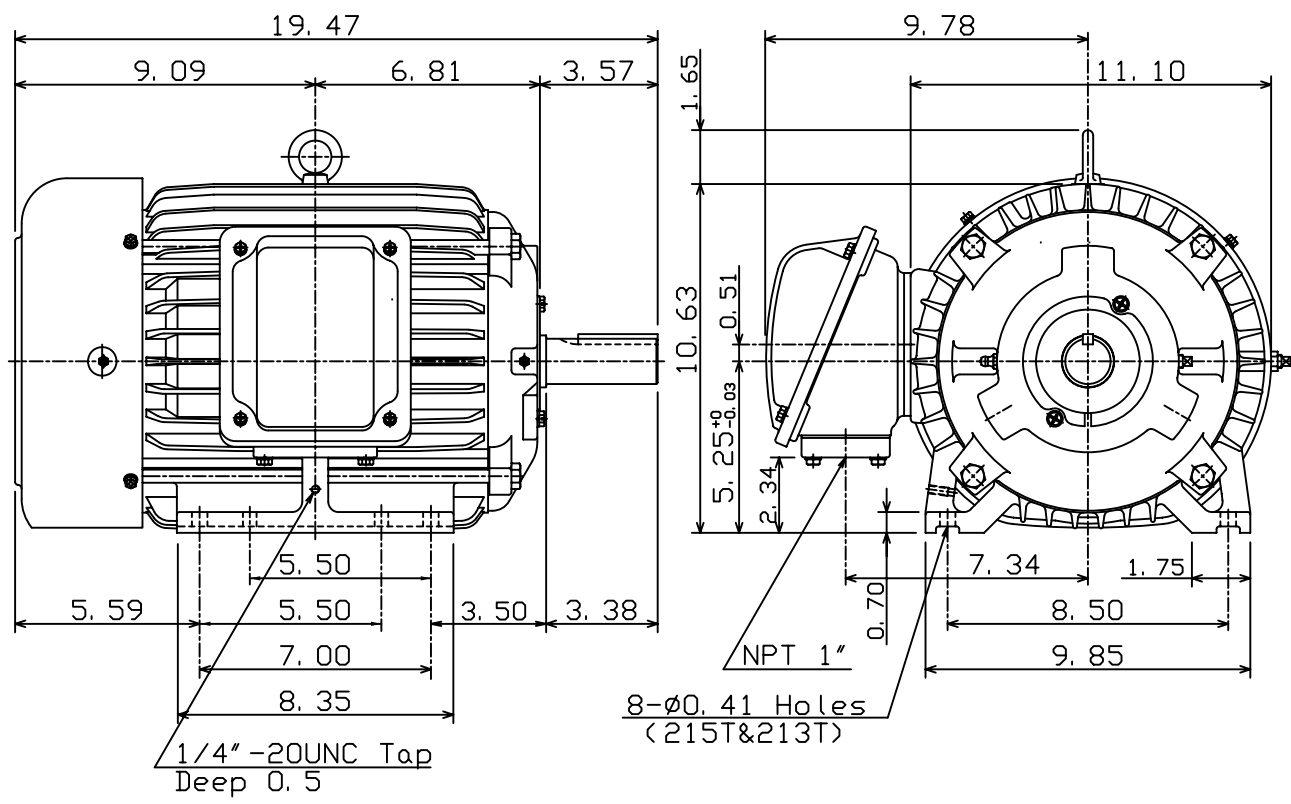

Note:
1. Motor Vibration: 7.5 μ .
2. Both End With Inpro/Seal.

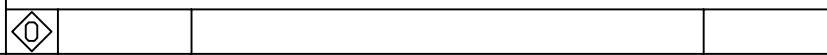

DWN.	C. S. LO	12-22-04
CHKD.	C. S. LO	12-27-04
APPD.	M. C. TSAI	12-27-04



DWG NO.
31049U595020