

DATE
Sept. 13, 2005
CAT. #: HB0052-50

OUTLINE DIMENSIONS
3-PHASE INDUCTION MOTOR

MOTOR TYPE:
AEHH8B
FRAME NO. 184T

Pole	HP	kW	Hz	VOLT	Syn. Speed r/min(rpm)
2	5	3.7	50	380	3000

Ins	Rating	Dimension in	Approx Weight	Bearings
F	CONT.	inches	95 lbs	DE: 6306ZC35C NDE: 6306ZC35C

Totally Enclosed Fan-Cooled Type, Squirrel-Cage Rotor.

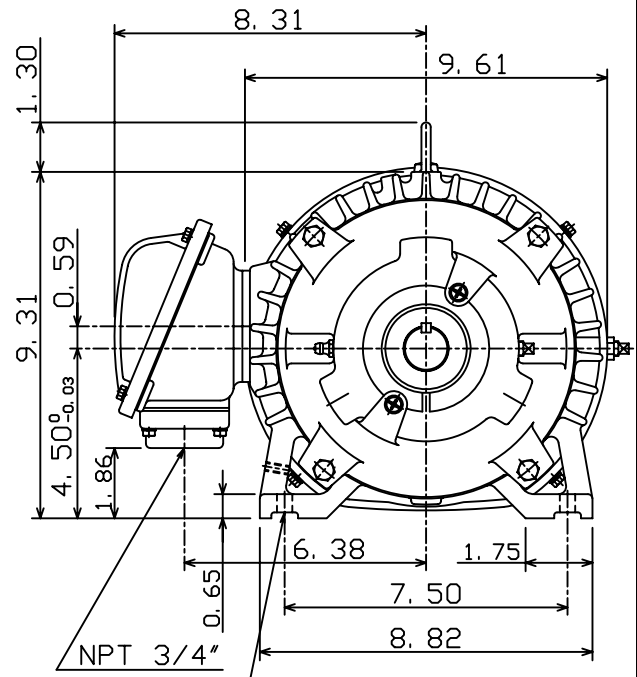
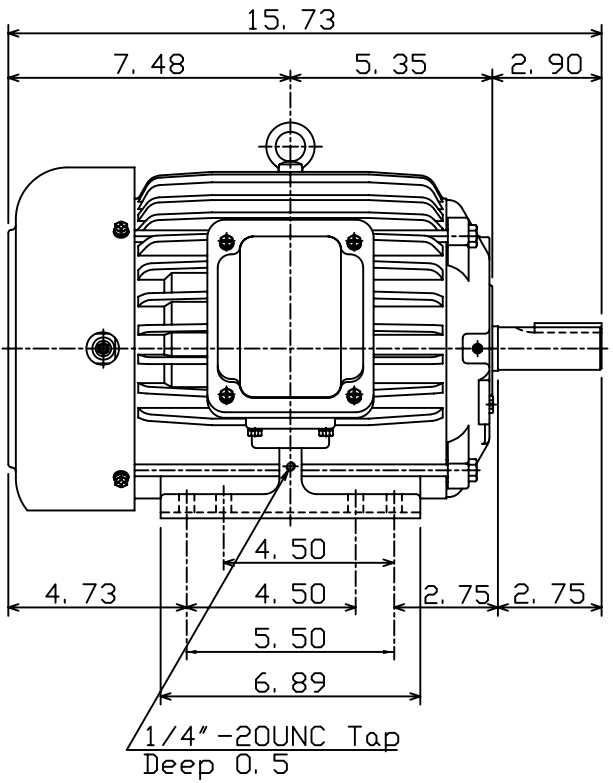

8-Ø0.41 HOLES
(184T&182T)

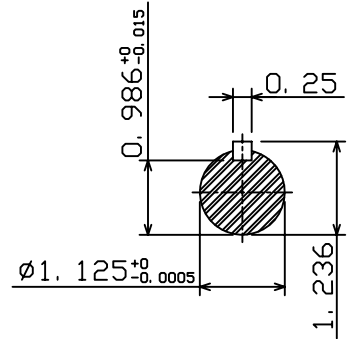
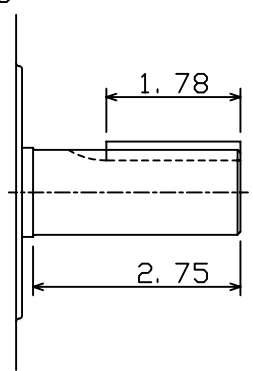

Note:
1. Motor Vibration: 7.5µ.
2. Both End With Inpro/Seal.

DWN.	C. S. LO	12-22-04
CHKD.	C. S. LO	12-27-04
APPD.	M. C. TSAI	12-27-04



DWG NO.
31049U593010