

DATE
OCTOBER 29, 2009
CAT. #: GPV0052C

OUTLINE DIMENSIONS
3-PHASE INDUCTION MOTOR

MOTOR TYPE:
AETHCF
FRAME NO. 184TC

Pole	HP	kW	Hz	VOLT	Syn.Speed r/min(rpm)
2	5	3.7	60	230/460	3600

Ins	Rating	Dimension in	Approx Weight	Bearings
F	CONT.	inches	97 lbs.	DE:6206ZZC3 NDE:6205ZZC3

Totally Enclosed Fan-Cooled Type, Squirrel-Cage Rotor.

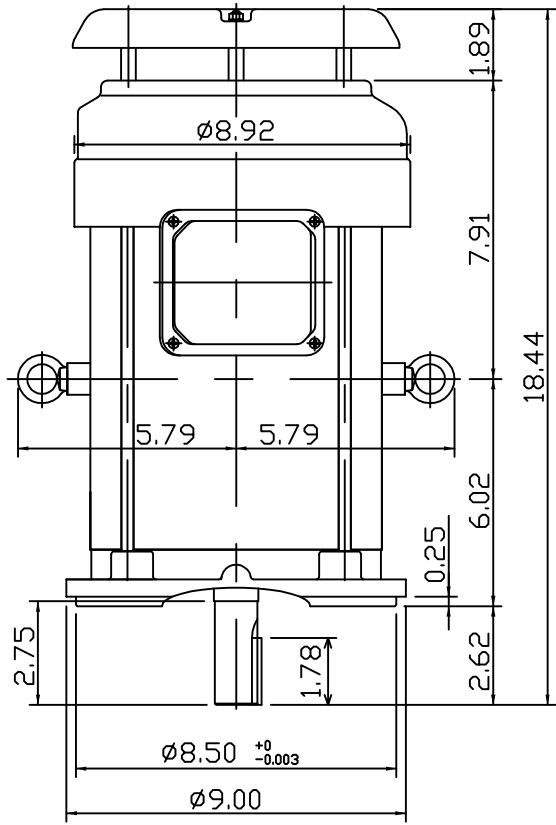

Ø1.10" CONDUIT HOLE

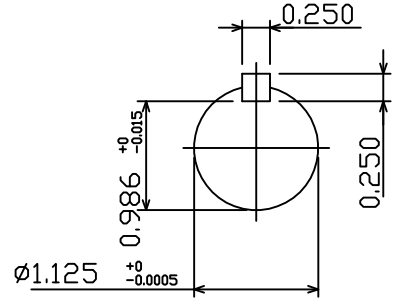
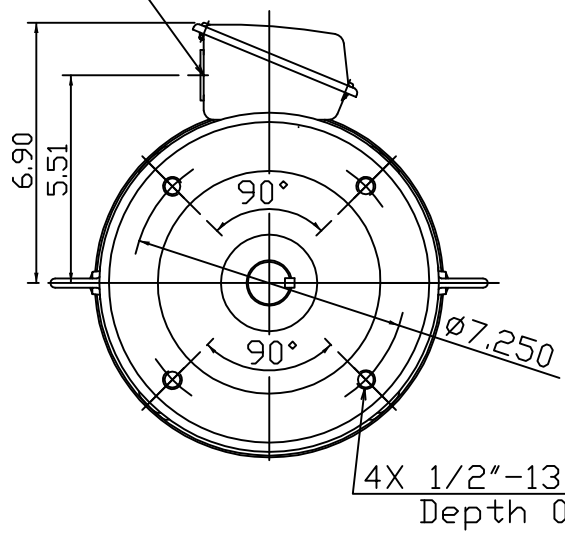

DWN, Y.S.LIN	10 04 09
CHKD, J.H.LIANG	10 06 09
APPD, M.C.TSAI	10 06 09



DWG NO.
31049R194010