

DATE
OCTOBER 19, 2009
CAT. #: GP7/54C

OUTLINE DIMENSIONS
3-PHASE INDUCTION MOTOR

MOTOR TYPE:
AEGHCF
FRAME NO. 213TC

Pole	HP	kW	Hz	VOLT	Syn.Speed r/min(rpm)
4	7.5	5.6	60	230/460	1800

Ins	Rating	Dimension in	Approx Weight	Bearings
F	CONT.	inches	140 LBS	DE: 6208ZZC3 NDE: 6206ZZC3

Totally Enclosed Fan-Cooled Type. Squirrel-Cage Rotor.

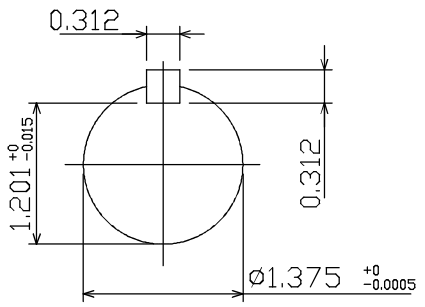
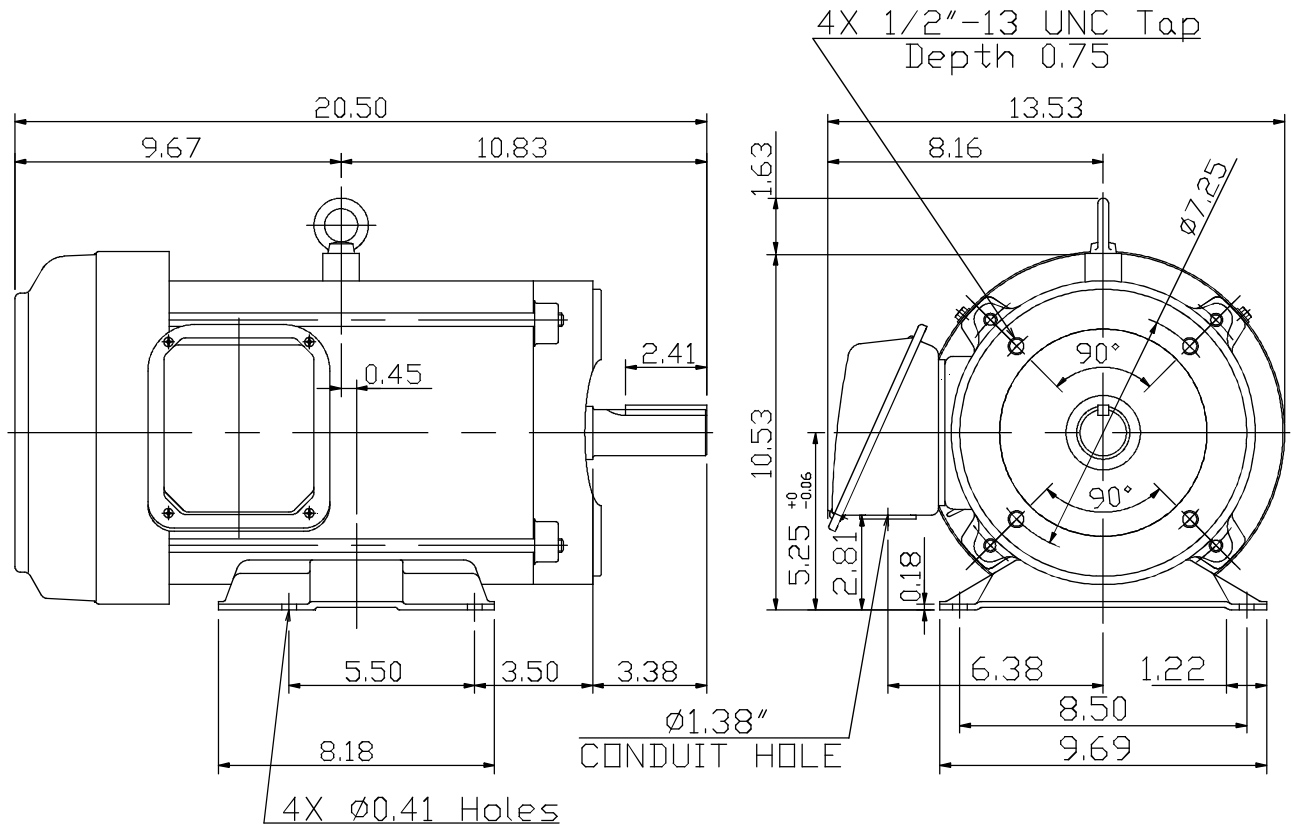

--	--	--	--

DWN. Y.S.LIN	10 05 09
CHKD. J.H.LIANG	10 06 09



DWG NO.
31049R173020