

DATE
May 19, 2011

CATALOG NO.
GHV0022C

OUTLINE DIMENSIONS
3-PHASE INDUCTION MOTOR

MODEL TYPE:
AETHCF

FRAME NO. 56C

Pole	HP	KW	Hz	VOLT	Syn. Speed R. P. M
2	2	1.5	60	230/460	3600

Ins.	Rating	Dimensions in	Approx Weight	Bearings
F	CONT.	inch	40 lbs.	DF: 6205ZZ NDE: 6204ZZ

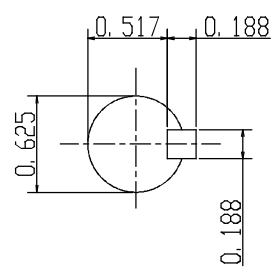
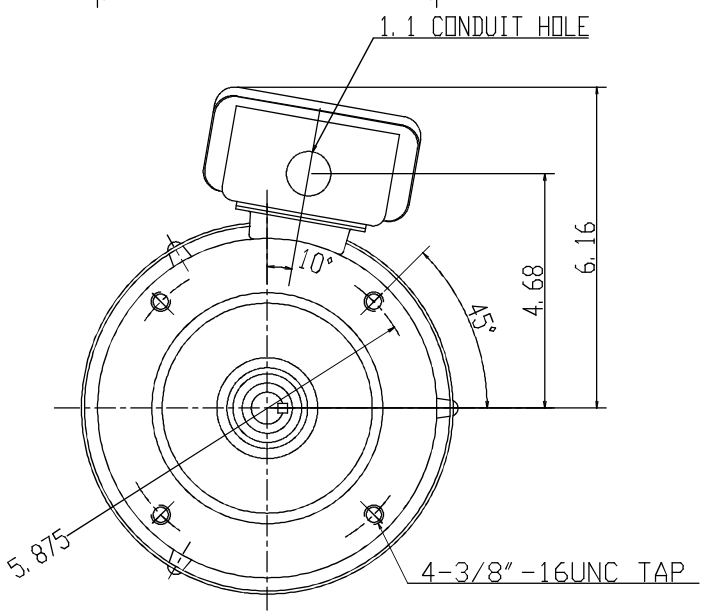
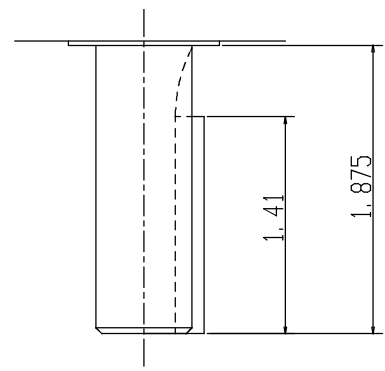
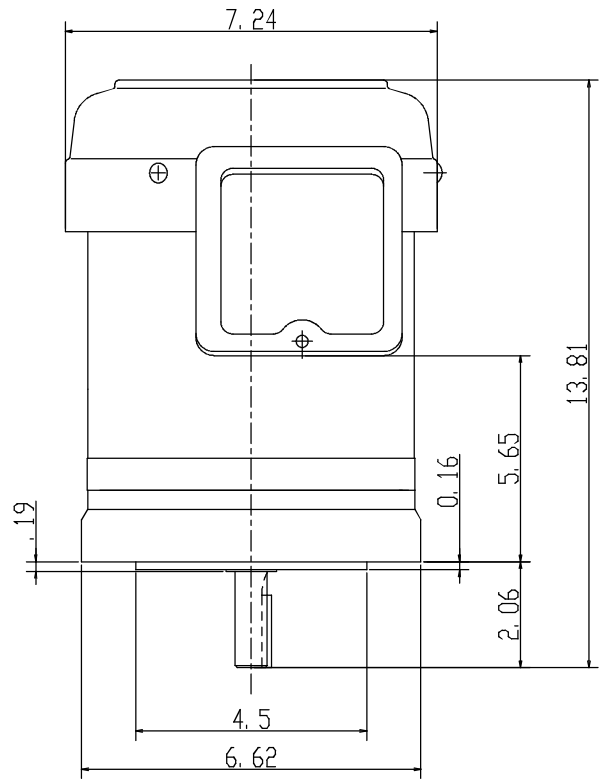

--	--	--	--	--	--	--	--

APPD.	W. H. TSAI	03 31 03
CHKD.	J. B. CHEN	03 31 03
DWN.	P. CHEN	03 01 03



DWG NO.
31049Z105
0724