

DATE
JAN. 4, 2007
CAT. #: EPV0756C-50

OUTLINE DIMENSIONS
3-PHASE INDUCTION MOTOR

MOTOR TYPE:
AEUH8NDC
FRAME NO. 405TC

Pole	HP	kW	Hz	VOLT	Syn. Speed r/min(rpm)
6	75	56	50	190/380	1000

Ins	Rating	Dimension in	Approx Weight	Bearings	
F	CONT.	inches	1315 LBS	DE: 6317	NDE: 6313

Totally Enclosed Fan Cooled Vertical Type. Squirrel-cage Rotor.

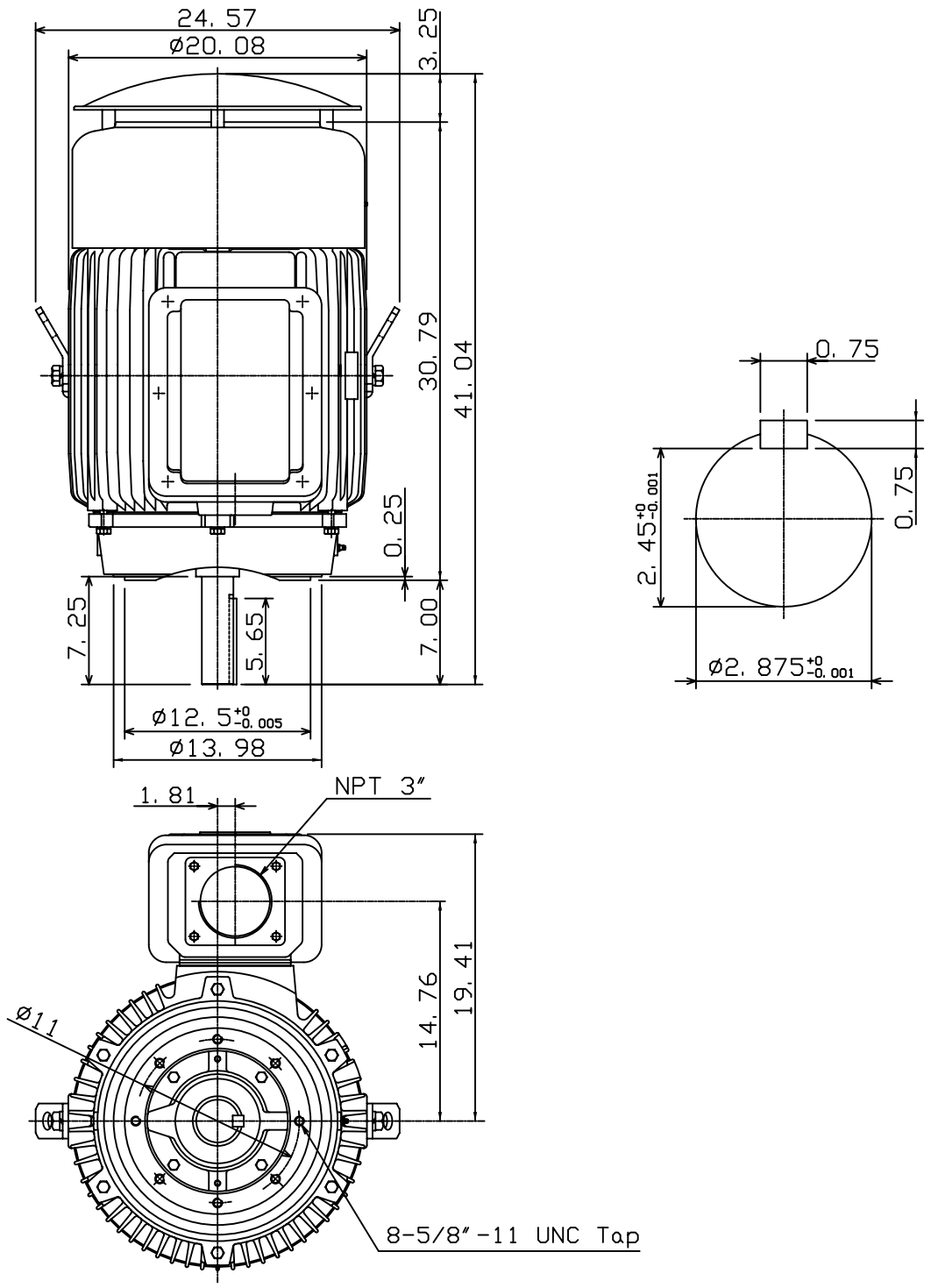

\diamond		
------------	--	--

DWN.	K. L. KUO	01-02-07
CHKD.	K. L. KUO	01-02-07
APPD.	M. C. TSAI	01-02-07



DWG NO.
31049M243360