

DATE
JAN. 4, 2007
CAT. #: EPV0402C

OUTLINE DIMENSIONS
3-PHASE INDUCTION MOTOR

MOTOR TYPE:
AEUH8NDC
FRAME NO. 324TSC

Pole	HP	kW	Hz	VOLT	Syn. Speed r/min(rpm)
2	40	30	60	230/460	3600

Ins	Rating	Dimension in	Approx Weight	Bearings
F	CONT.	inches	640 LBS	DE: 6312C3 NDE: 6212C3

Totally Enclosed Fan-cooled Vertical Type. Squirrel-cage Rotor.

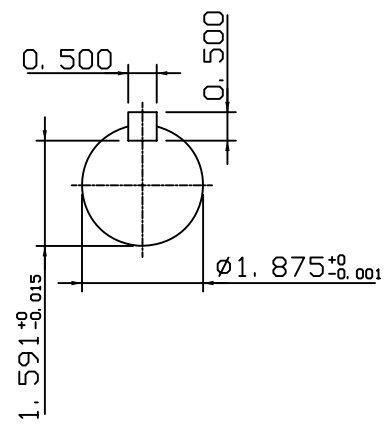
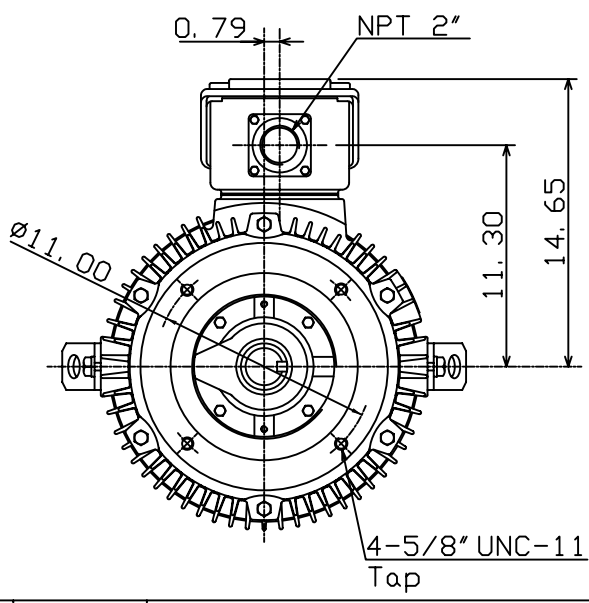
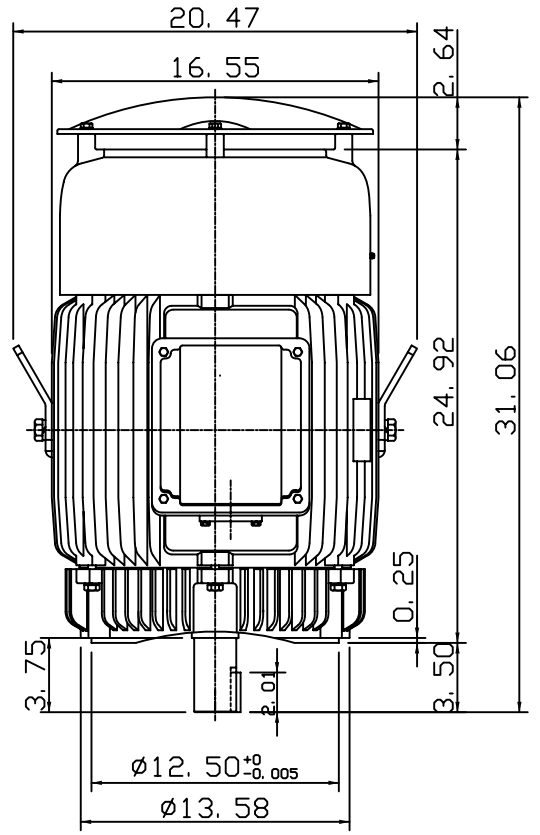

◇		
---	--	--

DWN.	K. L. KUO	01-02-07
CHKD.	K. L. KUO	01-02-07
APPD.	M. C. TSAI	01-02-07



DWG NO.
31057H204700