

DATE
JAN. 4, 2007
CAT. #: EPV0306C

OUTLINE DIMENSIONS
3-PHASE INDUCTION MOTOR

MOTOR TYPE:
AEUH8NDC
FRAME NO. 326TC

Pole	HP	kW	Hz	VOLT	Syn. Speed r/min(rpm)
6	30	22.4	60	230/460	1200

Ins	Rating	Dimension in	Approx Weight	Bearings
F	CONT.	inches	750 LBS	DE: 6312 NDE: 6212

Totally Enclosed Fan-cooled Vertical Type, Squirrel-cage Rotor.

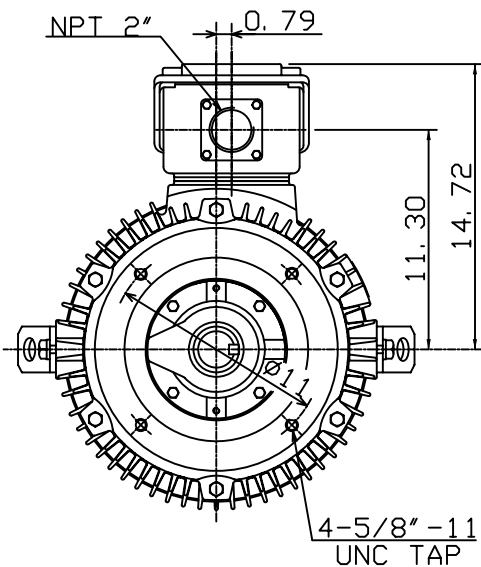
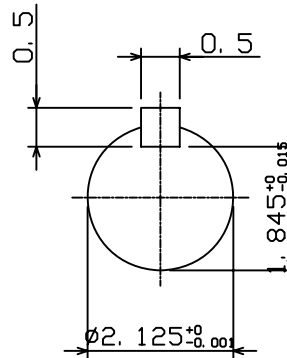
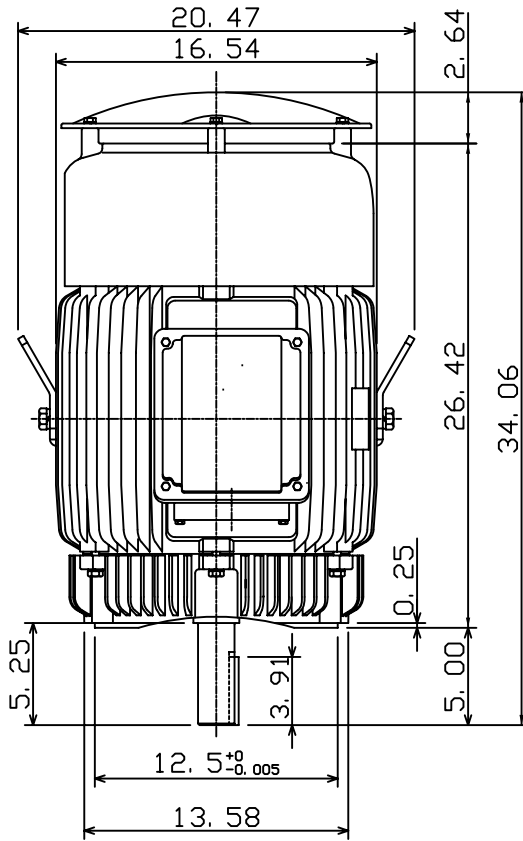

DWN. K. L. KUO 09-07-01
CHKD. C. H. KAO 09-20-01
APPD. Y. B. HUANG 09-20-01



DWG NO.
31057H337120